

JYZ-FF Fault Indicator	Version:	V2.0.1
	Module:	JYZ-FF
	Total Page:	30

JYZ-FF Fault Indicator User Manual



Four-Faith Corporation

Add: 11th Floor, A-06 Area, No.370, Chengyi Street, Jimei, Xiamen,
Fujian, China.

Tel: +86 17750019379

Fax: +86 592-5912735

Web: en.four-faith.net



Document Revised Record

Date	Version	Remark	Author
30 th Sep. 2018	V2.0.0	Initial Version	Barry Cai
30 th Aug. 2019	V2.0.1	<ol style="list-style-type: none"> 1) Update the new pictures due to SW tool upgrading 2) Update the value of parameters 3) Adjust the structure of the document 4) Add the dismounting instruction 	Lucas Ma

Copyright Notice

All contents in the files are protected by copyright law, and all copyrights are reserved by Xiamen Four-Faith Communication Technology Co., Ltd. Without written permission, all commercial use of the files from Four-Faith are forbidden, such as copy, distribute, reproduce the files, etc., but non-commercial purpose, downloaded or printed by individual (all files shall be not revised, and the copyright and other proprietorship notice shall be reserved) are welcome.

Trademark Notice

Four-Faith、四信、、、 are all registered trademarks of Xiamen Four-Faith Communication Technology Co., Ltd., illegal use of the name of Four-Faith, trademarks and other marks of Four-Faith is forbidden, unless written permission is authorized in advance.

Content

1. JYZ-FF Overview.....	5
2. Technical Specifications.....	6
3. Function Description.....	7
3.1 False Triggering Prevention.....	7
3.2 Short-circuit Detection.....	8
3.4 Load Current Value Upload.....	9
3.5 Low Battery Alarm.....	9
3.6 Fault Local Indication.....	9
3.7 Fault Remote Indication.....	10
3.8 Indicator Reset.....	10
4. Parameters Setting Instruction.....	11
4.1 DCU Parameters Setting.....	12
4.1.1 Telemetry Parameters.....	12
4.1.2 Teleindication Parameters.....	12
4.1.3 Time Calibration.....	13
4.1.4 Operational Parameters.....	14
4.1.5 IEC Settings.....	15
4.1.6 Telemetry Point List.....	16
4.1.7 Phone Numbers Settings.....	17
4.1.8 RF Parameter.....	18
4.1.9 MC Parameter.....	19
4.1.10 GPRS Settings.....	20
4.2 Indicator Parameters Setting.....	21
4.2.1 Run Parameter of Indicator.....	21
4.2.2 Current Parameter of Indicator.....	22
4.2.3 Ground Parameter of Indicator.....	23
5. Online Upgrading.....	24
5.1 Indicator Upgrading.....	24
5.2 DCU Upgrading.....	25
6. Dimensions.....	26
7. Mounting and Dismounting Instruction.....	27
7.1 Mounting.....	27
7.2 Dismounting.....	30

1.JYZ-FF Overview

Medium voltage distribution networks which have longer lines, various load and complex topology, usually take a longer time for line maintenance. Especially when fault occurs, there is a great significance for power supply reliability to find and locate fault point as soon as possible.

The earth-fault and short-circuit fault indicator type JYZ-FF are usually used in radial medium voltage (5~38KV, can be customized by 44KV, 69KV and 110KV) overhead line distribution networks, which neutral points are ineffectively grounded. Short-circuit fault and single-phase earthed fault can be detected and indicated by mechanical flag and three ultra-bright blinking LEDs, which can be seen from 360° sight.

The fault information and load current value can also be transmitted to the SCADA system. A data concentrator unit (DCU) will be equipped for data transmission from DCU to SCADA system by 2.5G/3G/4G networks. And the indicators talk to DCU by 433M module.

A mounting point usually have one DCU and three fault indicators (A, B, and C phase). One DCU can support 9 fault indicators at most.

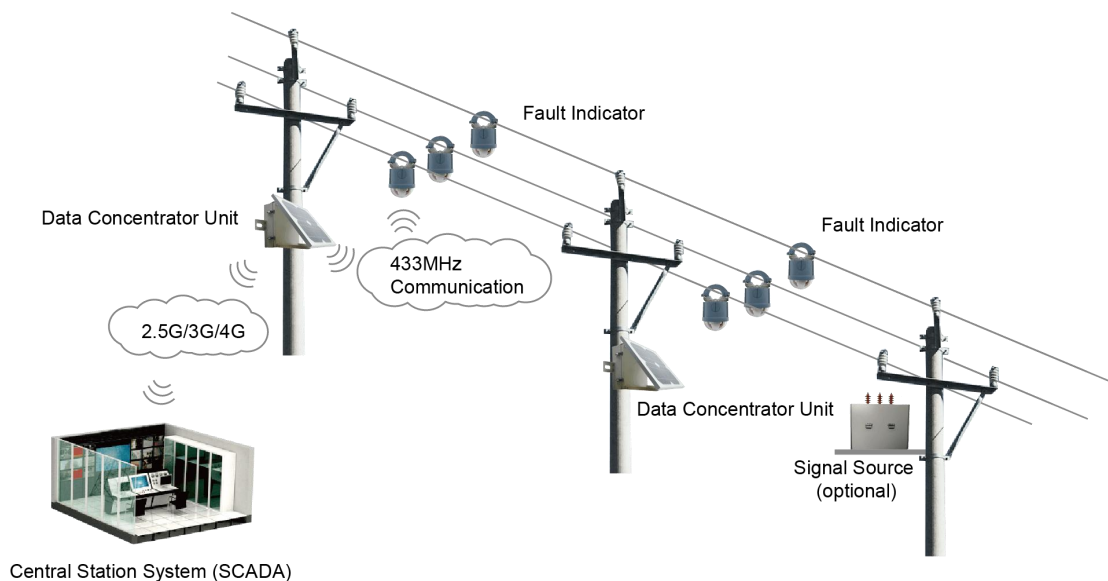

2. Technical Specifications

Parameter	Value
Voltage Range	5~38KV, can be customized by 44KV, 69KV and 110KV
Short-circuit trip current (phase to phase)	50~1200A adjustable, 1A step, 150A default
Earth-fault electrical field drop (phase to ground)	Adjustable, 1% step, 30% default
Earth-fault response delay	adjustable: 1s step, 30s default (minimum 1s)
Indication unit reset	<ol style="list-style-type: none"> 1. manual by magnet. 2. remote reset through SCADA system 3. time reset: adjustable, 1 second step, 24h default, max. 48h 4. Auto delay reset after repower, 1 second step, 30s default max 5min, only for permanent fault
Indicator Protection class	IP68
DCU Protection class	IP65
Internal type test	according to IEEE495-2007
Operation temperature range	-40~+70°C
Indicator battery	Lithium battery type AA 3.6V / 2.7Ah, replaceable
DCU battery	Rechargeable lithium battery 12V/7.8Ah
Life time of LED flashing	2000h
Battery life	approx. 10 years
Indicator Weight	approx. 0.62Kg
DCU Weight	approx. 3.6Kg
Load Current Accuracy	0A~300A ±3A 300A~800A ±1%
Cable diameter ranges	6mm~42mm
LED Blinking frequency	10 per minute, adjustable
LED delay	10ms default, adjustable
Max. load/fault Current	1200A
Current withstand	31.5KA/4s
Communication medium	Indicator to DCU: 433MHz/2.4GHz DCU to SCADA: 2.5G/3G/4G
Communication Protocol	Indicator to DCU: private DCU to SCADA: IEC101, IEC104, DNP3.0, Modbus

3. Function Description

3.1 False Triggering Prevention

(a) Inrush Current

Transformer of no-load closing and large load input will cause inrush current. Inrush current of overhead line is very high, regularly up to the fault current threshold, and the fault indicator can identify inrush current and ignore it automatically, and not act.

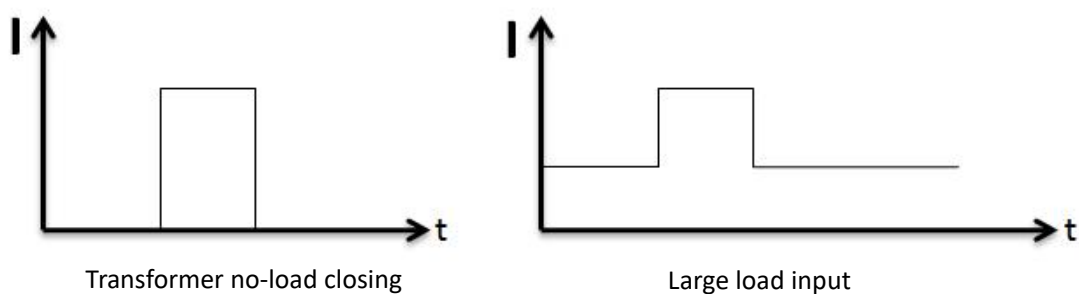

(b) Non-fault Line Reclosing

After fault occurs, the non-fault lines also have reclosing inrush current, and indicators can distinguish the feature, and not act.

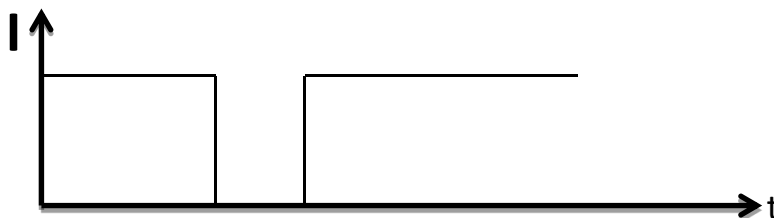

(c) Heavy Load Input Manually

When a heavy load acted on the line, the current can increase sharply. The line will lose power under the protection mechanism. The heavy current time Δt is longer than the duration time of short circuit current. It can be modified based on actual situation. Indicators can distinguish the feature, and not act.

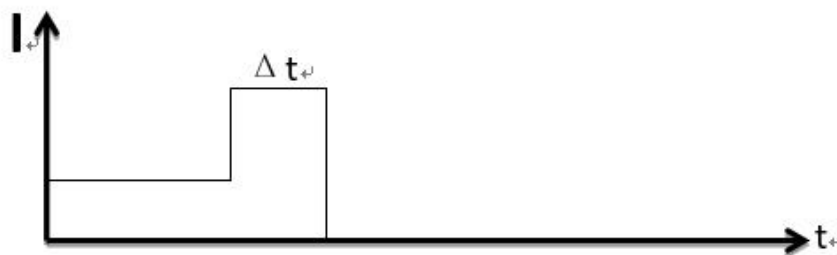

3.2 Short-circuit Detection

a) Permanent Fault

The fault indicator can detect permanent short-circuit fault by electrical field and load current change features. No matter how many automatic reclosing are operated, it is identified as a permanent fault if there is outage.

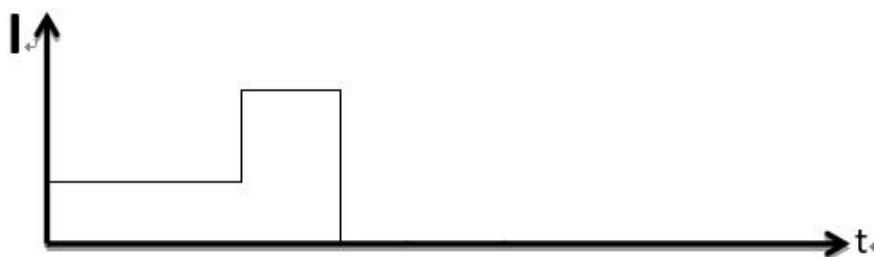

b) Transient Fault / Temporary Fault

If the fault is cleared by the automatic reclosing cycles and the line returns back to normal state, it is identified as a transient fault.

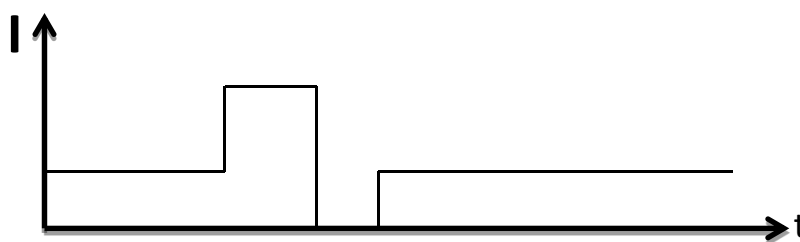

3.3 Earth-fault Detection

Drop of electrical field is the most important factor for earth-fault detection. The indicator can measure a bare voltage value which can reflect the change of electrical field.

After earth-fault occurs, there are a large number of transient high-frequency component and big capacitive current in the first half wave, and the electrical field will drop at the same time. This feature will be considered as an earth-fault if the transient current up to threshold value.

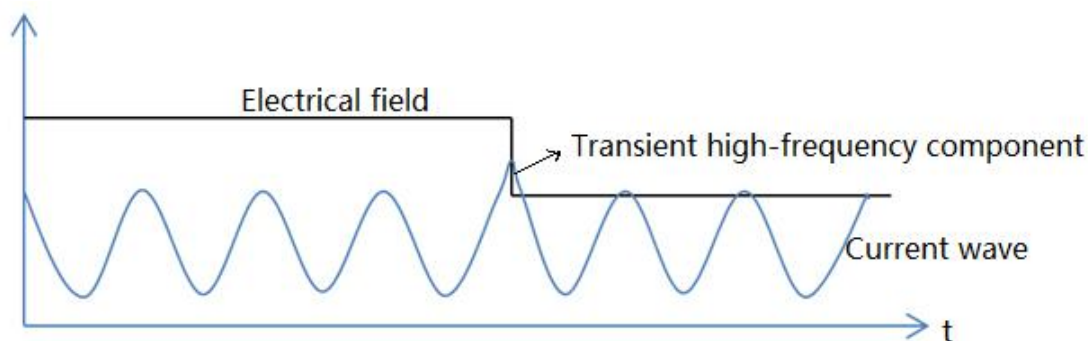

3.4 Load Current Value Upload

The indicator uploads current value to DCU and DCU uploads current value to SCADA within the configurable time (15 minutes default), and also uploads immediately when current value fluctuates at large amplitude. The fixed time and the amplitude are adjustable.

3.5 Low Battery Alarm

The battery of indicator is replaceable and the battery voltage can be measured every 20 milliseconds. The mechanical red flag will be activated and kept when battery voltage value less than threshold value. The low battery alarm will be also transmitted to SCADA system to remind the operation and maintenance personnel to change the battery.

The threshold classic value is 3.2V which can be adjusted by SW tools.

3.6 Fault Local Indication

Permanent fault, transient fault, and earth-fault have the same indication locally, that is LED blinking and mechanical red flag.

Red flag can be found easily at daylight, and blinking is obvious at night. Fault type can't be distinguished locally.

3.7 Fault Remote Indication

The fault information would also be transmitted and showed on SCADA system besides local display. You can find many useful information like fault type, load current value, battery value on SCADA system. Especially when fault occurs, the fault point would be located within a few minutes.

3.8 Indicator Reset

For permanent fault type, the indicator will be reset after a configurable time (0~5minutes, 1s step) when the line is re-powered. And for transient fault and earth-fault type, the indicator will be kept red flag and sustaining blinking for a configurable time (0~48 hours, 1s step), no matter if the line is re-powered or not. During the time of blinking, a new fault can be detected, and the reset time will be recalculated.

4 Parameters Setting Instruction

Before configuration, it is necessary to connect the PCBA of DCU with PC by the shipped RS232 conversion cable as following:

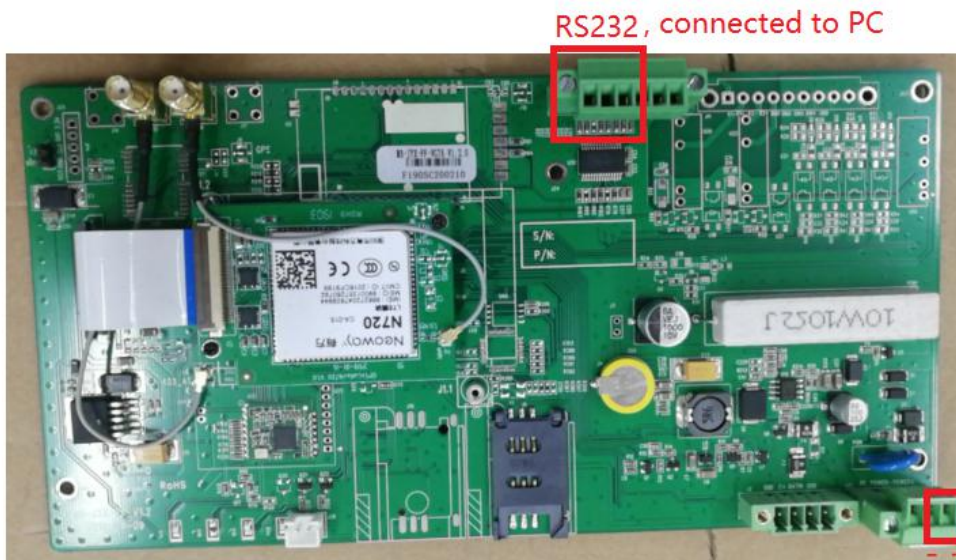

All the settings are configured through the shipped software tool (FaultIndicator.exe). It's necessary to have one PC to run this tool. **After you changed the value, you need to save it and restart DCU to make the change take effect.**

Open the SW tool, click “Serial Port Setting”. On the serial port setting interface, there will be the parameters of present opened serial port. If the parameters of the connected data concentrator unit don't conform with the default value, please select correct one and click “open”. Then you can click “initialization” on the top menu to test the link, if there is no returned error information, that means the communication between DCU and PC is normal.

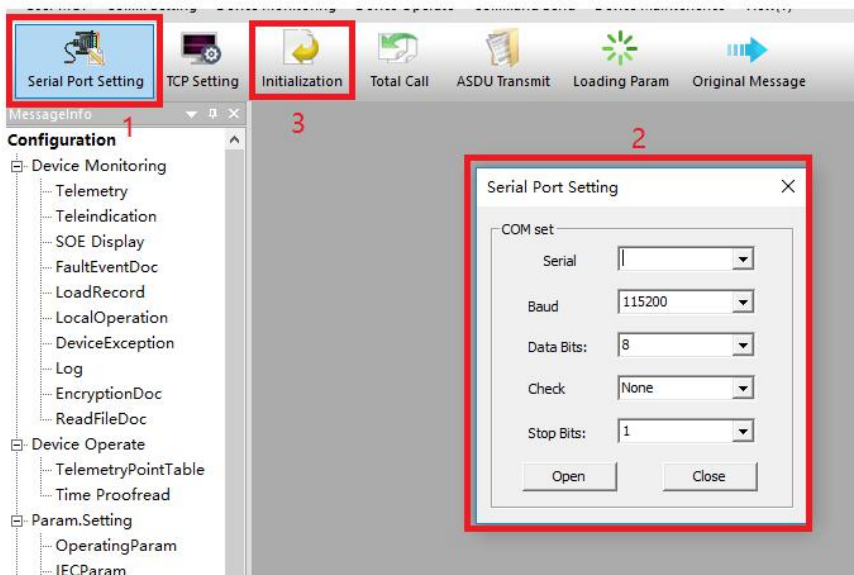

4.1 DCU Parameters Setting

4.1.1 Telemetry Parameters

Double click “Telemetry”, then click “Total Call”, you will see the value of telemetry.

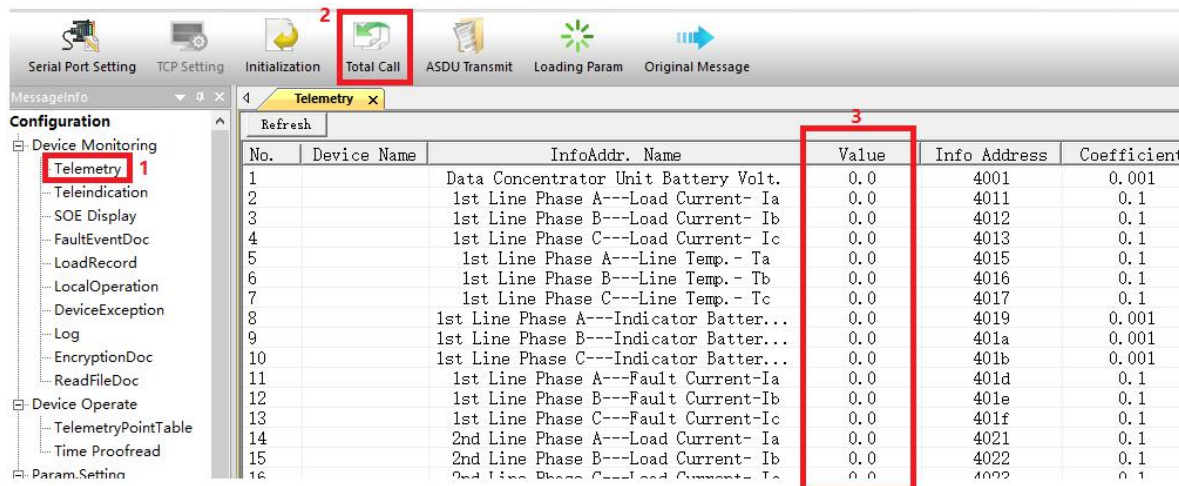

No.	Device Name	InfoAddr. Name	Value	Info Address	Coefficient
1		Data Concentrator Unit Battery Volt.	0.0	4001	0.001
2		1st Line Phase A---Load Current- Ia	0.0	4011	0.1
3		1st Line Phase B---Load Current- Ib	0.0	4012	0.1
4		1st Line Phase C---Load Current- Ic	0.0	4013	0.1
5		1st Line Phase A---Line Temp.- Ta	0.0	4015	0.1
6		1st Line Phase B---Line Temp.- Tb	0.0	4016	0.1
7		1st Line Phase C---Line Temp.- Tc	0.0	4017	0.1
8		1st Line Phase A---Indicator Batter...	0.0	4019	0.001
9		1st Line Phase B---Indicator Batter...	0.0	401a	0.001
10		1st Line Phase C---Indicator Batter...	0.0	401b	0.001
11		1st Line Phase A---Fault Current-Ia	0.0	401d	0.1
12		1st Line Phase B---Fault Current-Ib	0.0	401e	0.1
13		1st Line Phase C---Fault Current-Ic	0.0	401f	0.1
14		2nd Line Phase A---Load Current- Ia	0.0	4021	0.1
15		2nd Line Phase B---Load Current- Ib	0.0	4022	0.1
16		2nd Line Phase C---Load Current- Ic	0.0	4023	0.1

4.1.2 Teleindication Parameters

Double click “Teleindication”, then click “Total Call”, you will see the value of teleindication.

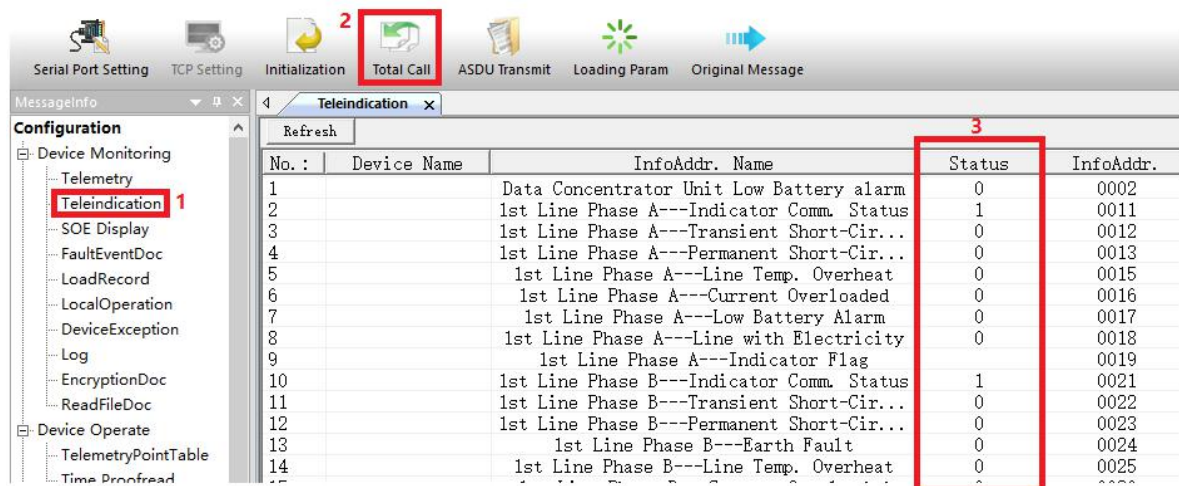

No. :	Device Name	InfoAddr. Name	Status	InfoAddr.
1		Data Concentrator Unit Low Battery alarm	0	0002
2		1st Line Phase A---Indicator Comm. Status	1	0011
3		1st Line Phase A---Transient Short-Cir...	0	0012
4		1st Line Phase A---Permanent Short-Cir...	0	0013
5		1st Line Phase A---Line Temp. Overheat	0	0015
6		1st Line Phase A---Current Overloaded	0	0016
7		1st Line Phase A---Low Battery Alarm	0	0017
8		1st Line Phase A---Line with Electricity	0	0018
9		1st Line Phase A---Indicator Flag	0	0019
10		1st Line Phase B---Indicator Comm. Status	1	0021
11		1st Line Phase B---Transient Short-Cir...	0	0022
12		1st Line Phase B---Permanent Short-Cir...	0	0023
13		1st Line Phase B---Earth Fault	0	0024
14		1st Line Phase B---Line Temp. Overheat	0	0025

4.1.3 Time Calibration

Double click “Time Proofread”, you will see the window shown as below

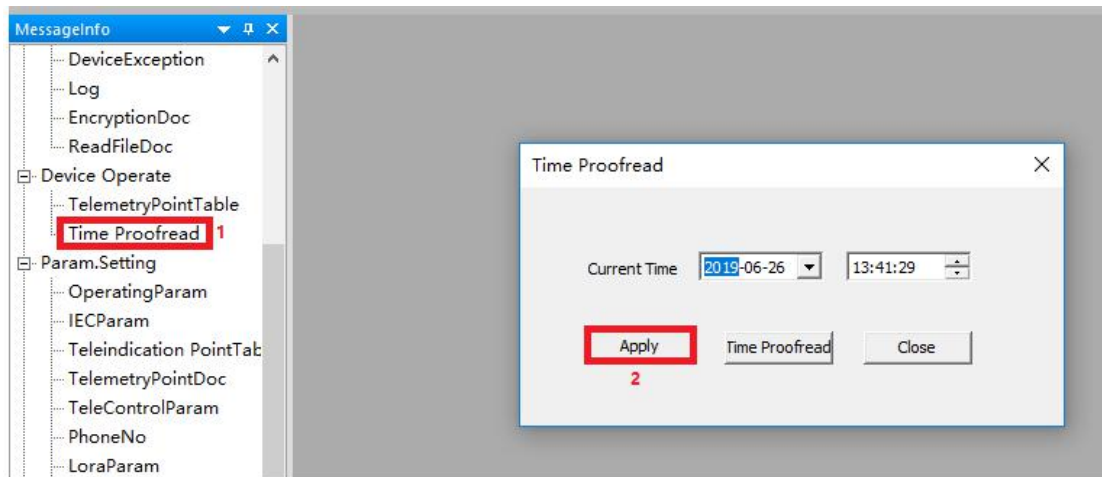

◆ **Apply:** Apply time proofread, you can calibrate the time.

◆ **Time Proofread:** You can read the time information from DCU

4.1.4 Operational Parameters

Double click “OperatingParam”, then click “Query”, you will see the value

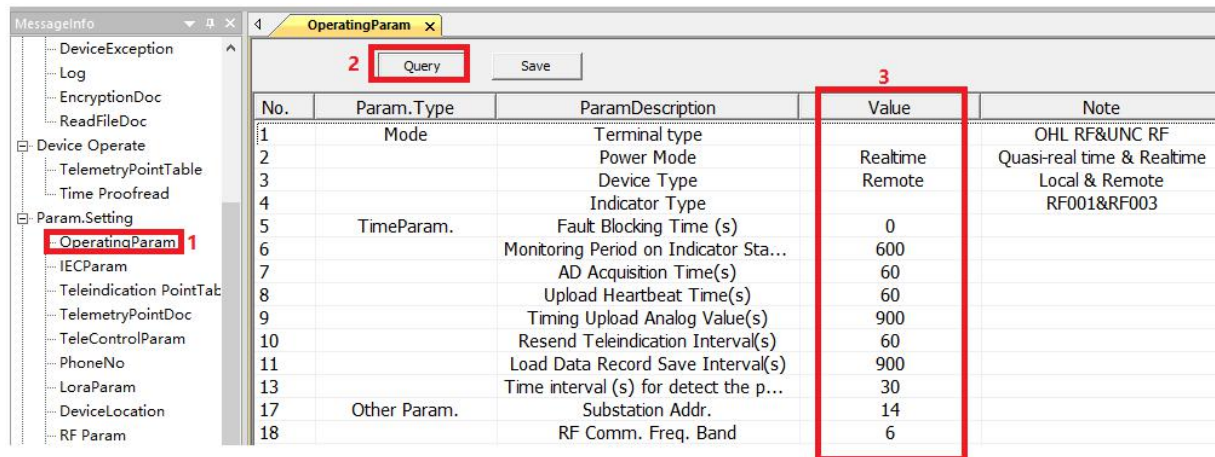

No.	Param.Type	ParamDescription	Value	Note
1	Mode	Terminal type		OHL RF&UNC RF
2		Power Mode	Realtime	Quasi-real time & Realtime
3		Device Type	Remote	Local & Remote
4		Indicator Type		RF001&RF003
5	TimeParam.	Fault Blocking Time (s)	0	
6		Monitoring Period on Indicator Sta...	600	
7		AD Acquisition Time(s)	60	
8		Upload Heartbeat Time(s)	60	
9		Timing Upload Analog Value(s)	900	
10		Resend Teleindication Interval(s)	60	
11		Load Data Record Save Interval(s)	900	
13		Time interval (s) for detect the p...	30	
17	Other Param.	Substation Addr.	14	
18		RF Comm. Freq. Band	6	

◆ Mode Selection

Terminal Type: include overhead RF and underground cable lines RF

Power mode: Real time and quasi-real time. When set to quasi-real time, device doesn't deal with network tasks.

Device Type: Local fault indicator or remote fault indicator

Indicator Type: not used

◆ Time Parameter

Fault blocking time(S): When the fault occurs to the indicator, it will be reported. When the time is out, the fault will be cleared.

Monitoring Period on Indicator Status(S): the communication period between indicator and Concentrator Unit. When the time is out it will report the status of the indicator.

AD acquisition Time(S): Interval time of solar panel voltage & battery voltage acquisition

Upload heartbeat time(S): heartbeat interval time

Timing upload analog value: Period of telemetry upload time

Resend Teleindication interval(S): when SOE timeout, retransmission time

Load Data Record Save Interval: Period of save time for load

◆ **Other Parameters**

Substation Addr.: ASDU/Link address of 101 communication protocol

RF Comm. Freq. Band: RF 433 communication Frequency.

Absolute Threshold of Telemetry, Relative Threshold of Telemetry: when the telemetry reaches these two conditions, will upload the telemetry to the server station.

Absolute Threshold of Temp.: not used.

4.1.5 IEC Settings

For different customers’ requirements, the user can set the specifications of 101 protocol. After the setting, user need to restart terminal for the setting to take effect. Specific settings are as follows:

Firstly double click “IECParam”, then click “Query”, you will see the value of parameters:

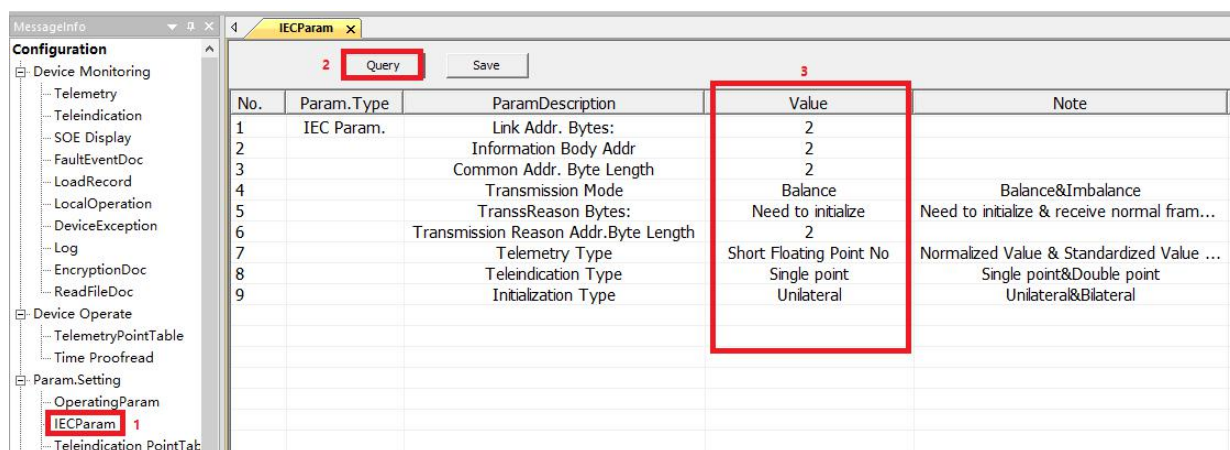

No.	Param.Type	ParamDescription	Value	Note
1	IEC Param.	Link Addr. Bytes:	2	
2		Information Body Addr	2	
3		Common Addr. Byte Length	2	
4		Transmission Mode	Balance	Balance&Imbalance
5		TransReason Bytes:	Need to initialize	Need to initialize & receive normal fram...
6		Transmission Reason Addr.Byte Length	2	
7		Telemetry Type	Short Floating Point No	Normalized Value & Standardized Value ...
8		Teleindication Type	Single point	Single point&Double point
9		Initialization Type	Unilateral	Unilateral&Bilateral

- ◆ Parameters “Link Addr. Bytes”, “Information Body Addr”, “Common Addr. Byte Length” and “Transmission Reason Addr. Byte Length” mean the length of corresponding value
- ◆ **Transmission Mode:** equilibrium mode or non-equilibrium mode of 101 protocol.
- ◆ **Telemetry Type:** data type of telemetry
- ◆ **Teleindication Type:** data type of teleindication
- ◆ **Initialization Type:** you can choose if only DCU is initialized or both DCU and main station are initialized

4.1.6 Telemetry Point List

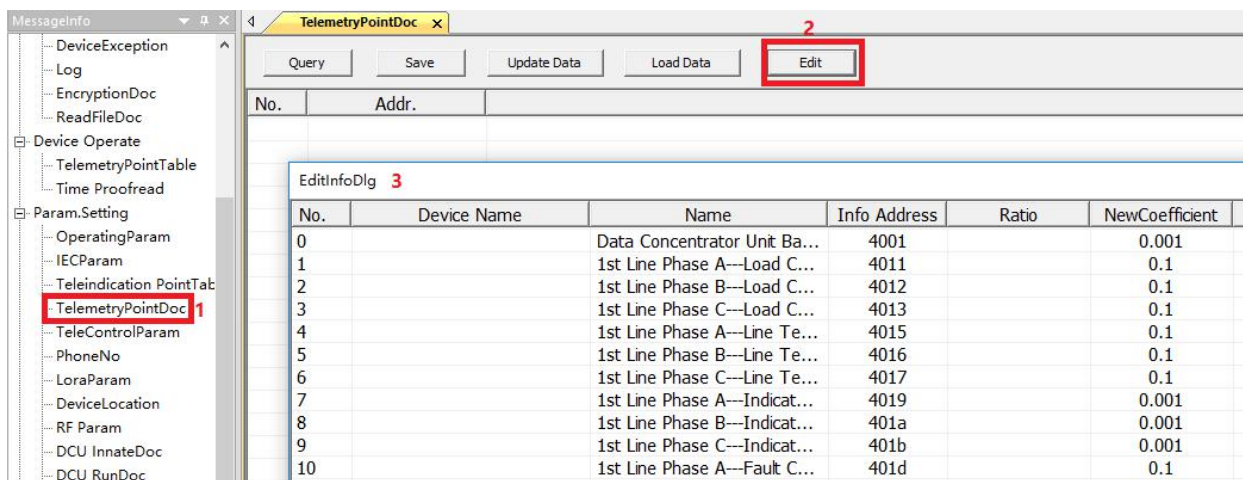

Double click “TelemetryPointDoc”, then click “Edit”, you will see interface window as below. You can check, add and modify Name and Info Address of the under-surveillance object.

EditInfoDlg

No.	Device Name	Name	Info Address	Ratio	NewCoefficient
0		Data Concentrator Unit Ba...	4001		0.001
1		1st Line Phase A---Load C...	4011		0.1
2		1st Line Phase B---Load C...	4012		0.1
3		1st Line Phase C---Load C...	4013		0.1
4		1st Line Phase A---Line Te...	4015		0.1
5		1st Line Phase B---Line Te...	4016		0.1
6		1st Line Phase C---Line Te...	4017		0.1
7		1st Line Phase A---Indicat...	4019		0.001
8		1st Line Phase B---Indicat...	401a		0.001
9		1st Line Phase C---Indicat...	401b		0.001
10		1st Line Phase A---Fault C...	401c		0.1
11		1st Line Phase B---Fault C...	401d		0.1
12		1st Line Phase C---Fault C...	401e		0.1
13		2nd Line Phase A---Load C...	4021		0.1
14		2nd Line Phase B---Load C...	4022		0.1
15		2nd Line Phase C---Load C...	4023		0.1
16		2nd Line Phase A---Line T...	4025		0.1
17		2nd Line Phase B---Line T...	4026		0.1
18		2nd Line Phase C---Line T...	4027		0.1
19		2nd Line Phase A---Indicat...	4029		0.001
20		2nd Line Phase B---Indicat...	402a		0.001
21		2nd Line Phase C---Indicat...	402b		0.001
22		2nd Line Phase A---Fault C...	402c		0.1
23		2nd Line Phase B---Fault C...	402d		0.1
24		2nd Line Phase C---Fault C...	402e		0.1
25		3rd Line Phase A---Load C...	4031		0.1
26		3rd Line Phase B---Load C...	4032		0.1

new change delete import export OK cancel

The Operation of “Teleindication PointTable” is the same.

4.1.7 Phone Numbers Settings

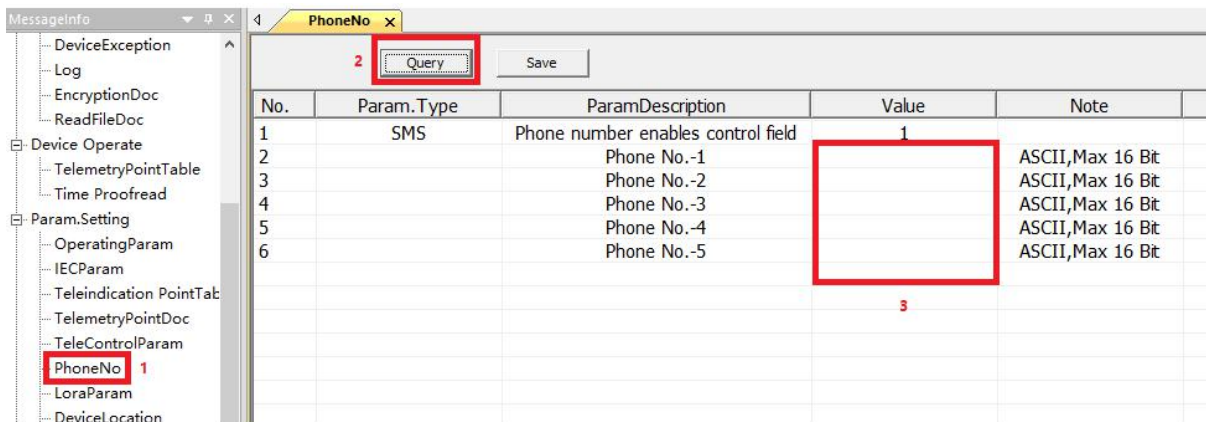

- ◆ Phone numbers activation setting: in the login window of SW FaultIndicator.exe, you need to select “Sms”

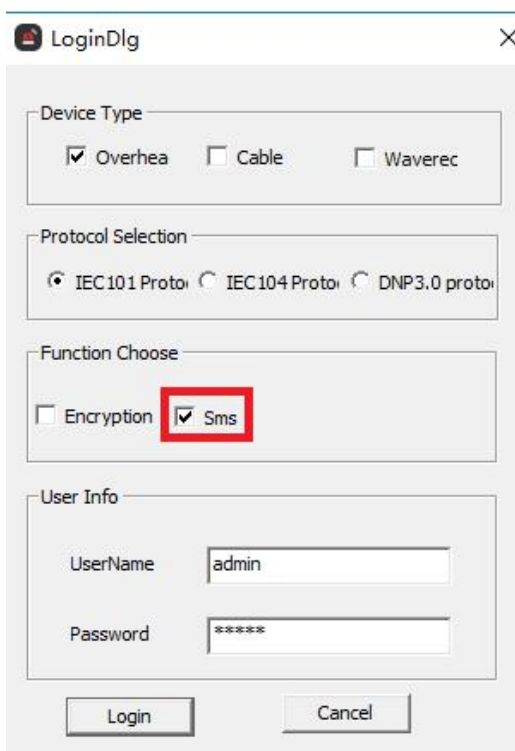

- ◆ Phone Numbers: Enter the correct phone number and save.

4.1.8 RF Parameter

Double click “RF Param”, then click “Query”, you will see the value of parameters

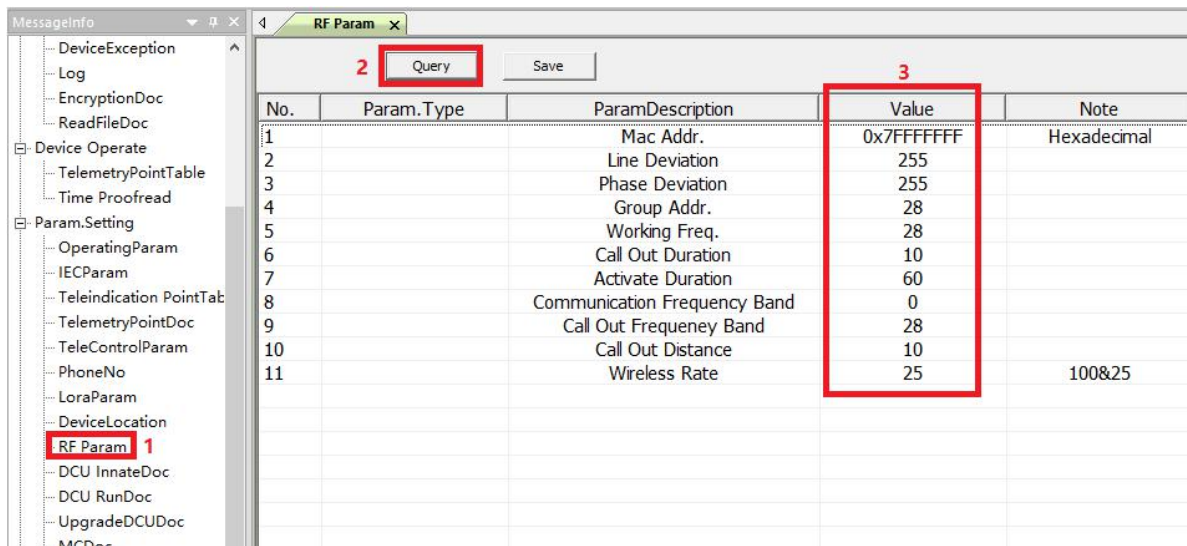

- ◆ **Group Addr. and Working Freq.:** these two values must be the same with DCU’s, they are used for matching between indicator and DCU.
- ◆ **Call out Duration:** the duration of call out
- ◆ **Activate Duration:** the duration time of DCU after it is woken up.
- ◆ **Communication Frequency Band:** communication frequency is 433MHz
- ◆ **Call out Frequency Band:** frequency band during calling out
- ◆ **Call Out Distance:** the distance between indicator and DCU during calling out
- ◆ **Wireless Rate:** the speed of communication between indicator and DCU

4.1.9 MC Parameter

If there are DCU substations that communicate with master DCU with Lora, you can add the address of sub-DCU here

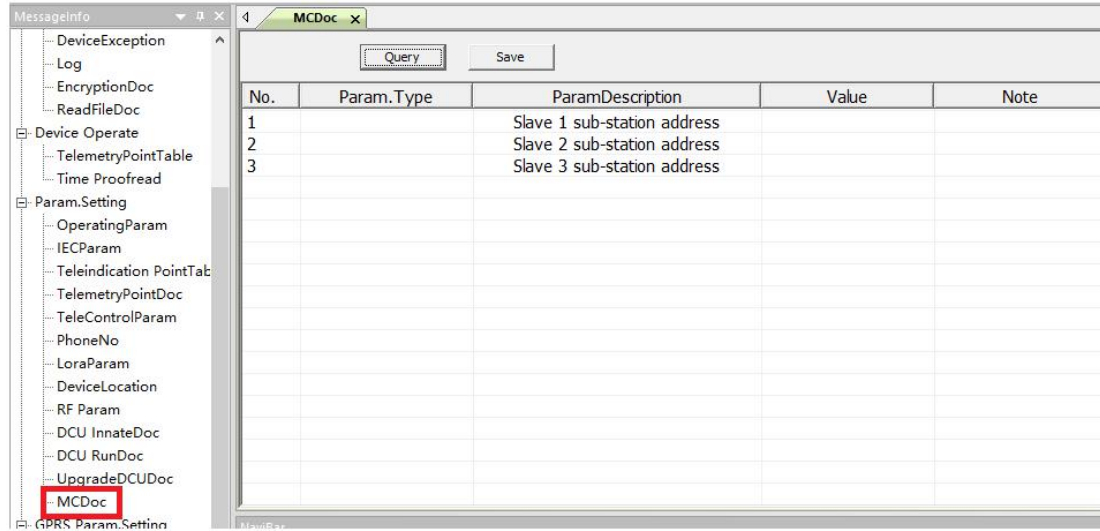

4.1.10 GPRS Settings

Double click “GPRSParam”, then click “Query”, you will see the value of GRPS parameters

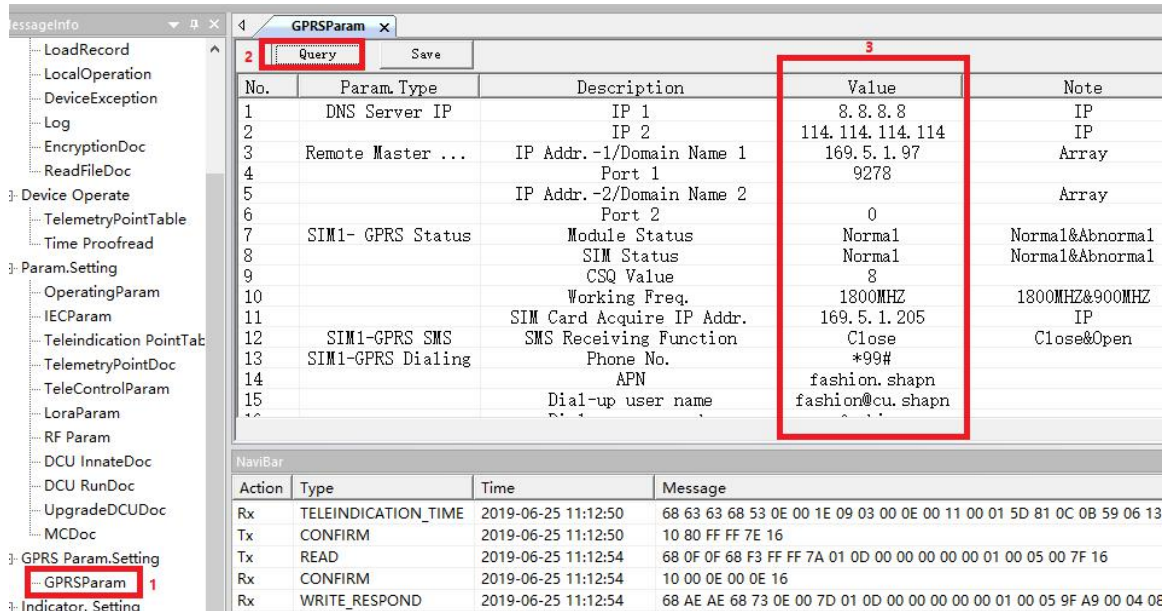

◆ **DNS server IP**

It is used to set the DNS server IP. When the remote host uses domain name, the “value” must be fulfilled with the DNS server IP, e.g. 114.114.114.114.

Support 2 DNS server IP, different one corresponding to different SIM card

◆ **Remote Master IP and Port**

It is used to set the remote host (main station) IP and port

Support 2 remote host IP or Domain name, different one corresponding to different SIM card

◆ **SIM1 GPRS Status**

The GPRS status cannot be set. It is used to check the module conditions in the data concentrator, Module status, SIM card status, CSQ value, working frequency and the SIM card IP address are obtained by the card.

◆ **SIM1 GPRS SMS**

It is used to set the receiving of message, “close” means OFF, “open” means ON.

◆ **SIM1 GPRS Dialing**

If SIM card is public network, just take the default value, otherwise you need to get information from SIM card supplier

4.2 Indicator Parameters Setting

4.2.1 Run Parameter of Indicator

Double click “IndicatorRunParam”, then select the line and phase of indicator, click “read” button, you will see the result shown as below:

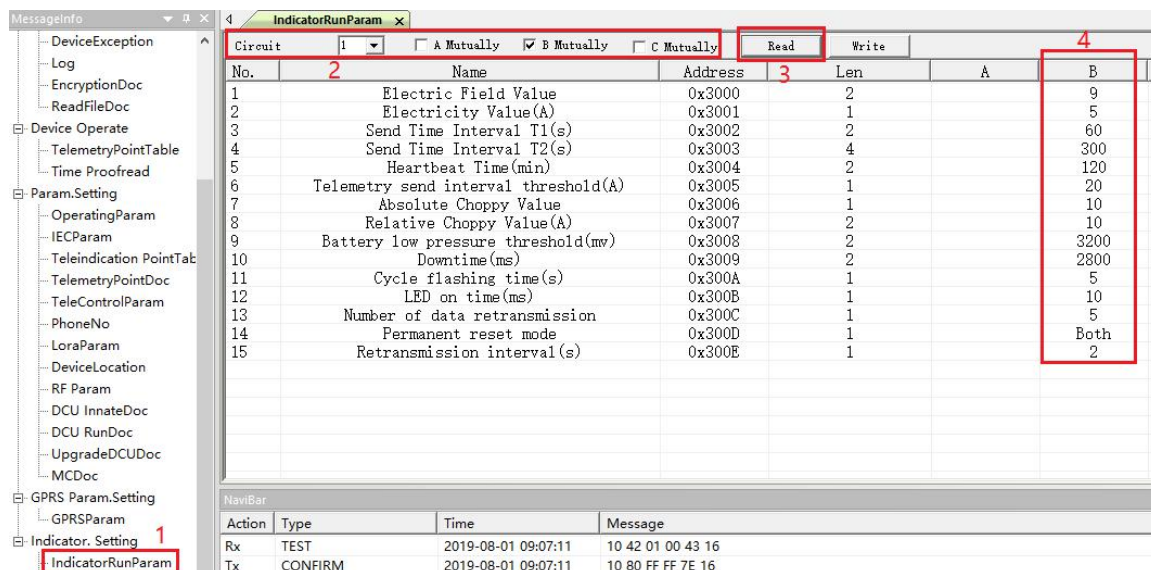

The screenshot shows the 'IndicatorRunParam' window with a table of parameters. The 'Read' button is highlighted in red. The table below is a representation of the data shown in the screenshot:

No.	Name	Address	Len	A	B
1	Electric Field Value	0x3000	2		9
2	Electricity Value(A)	0x3001	1		5
3	Send Time Interval T1(s)	0x3002	2		60
4	Send Time Interval T2(s)	0x3003	4		300
5	Heartbeat Time(min)	0x3004	2		120
6	Telemetry send interval threshold(A)	0x3005	1		20
7	Absolute Choppy Value	0x3006	1		10
8	Relative Choppy Value(A)	0x3007	2		10
9	Battery low pressure threshold(mv)	0x3008	2		3200
10	Downtime(ms)	0x3009	2		2800
11	Cycle flashing time(s)	0x300A	1		5
12	LED on time(ms)	0x300B	1		10
13	Number of data retransmission	0x300C	1		5
14	Permanent reset mode	0x300D	1		Both
15	Retransmission interval(s)	0x300E	1		2

Below the table is a 'NavBar' section with columns: Action, Type, Time, Message.

Action	Type	Time	Message
Rx	TEST	2019-08-01 09:07:11	10 42 01 00 43 16
Tx	CONFIRM	2019-08-01 09:07:11	10 80 FF FF 7E 16

- ◆ **Electric Field Value:** One of base that the line powered or not. It will be adjusted according to insulated line and bare line
- ◆ **Electricity Value(A):** The other base that the line powered or not. It is related to short-circuit and earth-fault judgment and not recommended to modify, 5A default
- ◆ **Send Time Interval T1(s):** The load current upload period. When Load current value is greater than “Telemetry send interval threshold”, indicator uploads load current at this interval. 60 seconds default
- ◆ **Send Time Interval T2(s):** The load current upload period. When Load current value less than “Telemetry send interval threshold” and greater than “Electricity value”, indicator uploads load current at this interval. 300 seconds default.
- ◆ **Heartbeat Time(min):** The heartbeat period of outage. 120 minutes default.
- ◆ **Telemetry send interval threshold(A):** the current value to distinguish the interval of load current update, 20A default
- ◆ **Absolute Choppy Value(A):** The current absolute mutation value, 10A default
- ◆ **Relative Choppy Value:** The current relative mutation value, 10% default
- ◆ **Battery low pressure threshold(mv):** threshold value of low battery alarm, 3.2V default.

- ◆ **Downtime(ms):** load current measurement interval when there is no power in the line,
- ◆ **Cycle flashing time(s):** The period of blinking, 5 seconds default.
- ◆ **LED on time(ms):** The delay time of LED light up. 10 milliseconds default.
- ◆ **Number of data retransmission:** data re-transmitted times when communication failure. 5 default
- ◆ **Permanent reset mode:** The indicators reset model for permanent fault.
- ◆ **Retransmission interval(s):** Data re-transmitted period when communication failure. 2seconds default

4.2.2 Current Parameter of Indicator

Double click “IndicatorCurrentParam”, then select the line and phase of indicator, click “read” button, you will see the result shown as below:

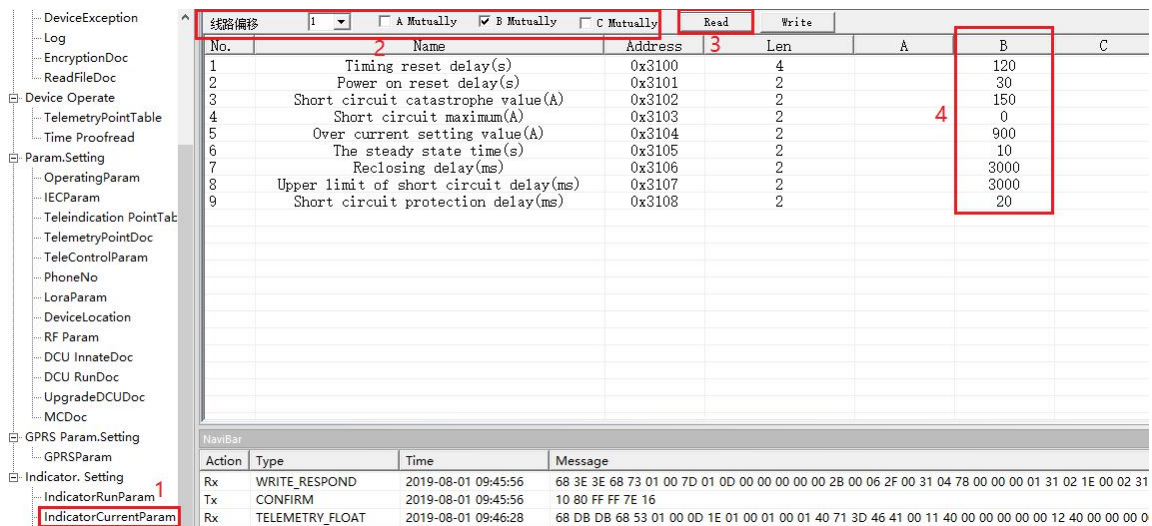

No.	Name	Address	Len	A	B	C
1	Timing reset delay(s)	0x3100	4		120	
2	Power on reset delay(s)	0x3101	2		30	
3	Short circuit catastrophe value(A)	0x3102	2		150	
4	Short circuit maximum(A)	0x3103	2		0	
5	Over current setting value(A)	0x3104	2		900	
6	The steady state time(s)	0x3105	2		10	
7	Reclosing delay(ms)	0x3106	2		3000	
8	Upper limit of short circuit delay(ms)	0x3107	2		3000	
9	Short circuit protection delay(ms)	0x3108	2		20	

- ◆ **Timing reset delay(s):** The auto-reset delay time of permanent, transient and earth fault. 120 seconds default
- ◆ **Power on reset delay(s):** The auto-reset delay time of permanent fault after the line repowered. 30 seconds default
- ◆ **Short circuit catastrophe value(A):** The minimum change value to judge short-circuit fault, 150A default. It can be adjusted according to the real situation.
- ◆ **Short circuit maximum(A):** not used
- ◆ **Over current setting value(A):** The threshold of over-current value, 900A default
- ◆ **The steady state time(s):** The line power and the indicator charge time. It is necessary for fault detection. 10 seconds default.

- ◆ **Reclosing delay(ms):** To distinguish permanent fault and transient fault. If the line is outage after the reclosing time, a permanent fault will be confirmed. Then otherwise, it is a transient fault. 3000 milliseconds default.
- ◆ **Upper limit of short circuit delay(ms):** The maximum time of short-circuit current sustains. 3000 milliseconds default.
- ◆ **Short circuit protection delay(ms):** The minimum time of short-circuit current sustains. 20 milliseconds default

4.2.3 Ground Parameter of Indicator

Double click “IndicatorGroundParam”, then select the line and phase of indicator, click “read” button, you will see the result shown as below. You can just take the default value.

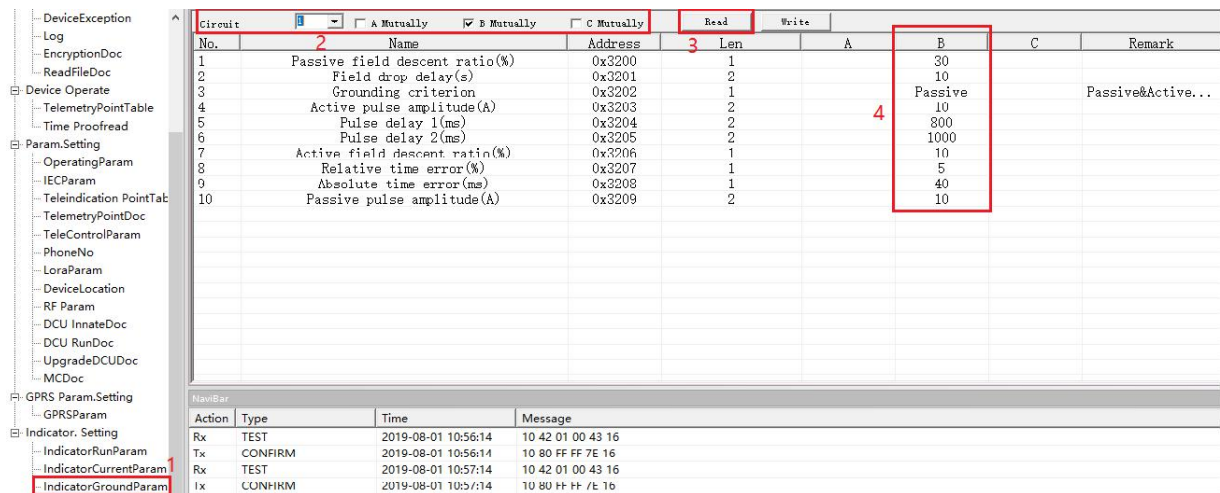

The screenshot shows the 'IndicatorGroundParam' configuration table with the following data:

No.	Name	Address	Len	A	B	C	Remark
1	Passive field descent ratio(%)	0x3200	1		30		
2	Field drop delay(s)	0x3201	2		10		
3	Grounding criterion	0x3202	1		Passive		Passive@Active...
4	Active pulse amplitude(A)	0x3203	2		10		
5	Pulse delay 1(ms)	0x3204	2		800		
6	Pulse delay 2(ms)	0x3205	2		1000		
7	Active field descent ratio(%)	0x3206	1		10		
8	Relative time error(%)	0x3207	1		5		
9	Absolute time error(ms)	0x3208	1		40		
10	Passive pulse amplitude(A)	0x3209	2		10		

Below the table is a 'NavBar' window showing a log of actions:

Action	Type	Time	Message
Rx	TEST	2019-08-01 10:56:14	10 42 01 00 43 16
Tx	CONFIRM	2019-08-01 10:56:14	10 80 FF FF 7E 16
Rx	TEST	2019-08-01 10:57:14	10 42 01 00 43 16
Tx	CONFIRM	2019-08-01 10:57:14	10 80 FF FF 7E 16

5 Online Upgrading

5.1 Indicator Upgrading

The indicators can be updated online by wireless Tools. First of all, select the program file that will be wrote by “Browse file”. And then load the indicator which needs to be updated. Click the button “En_Update” to enter into update state, the LED will be blinking continuously.

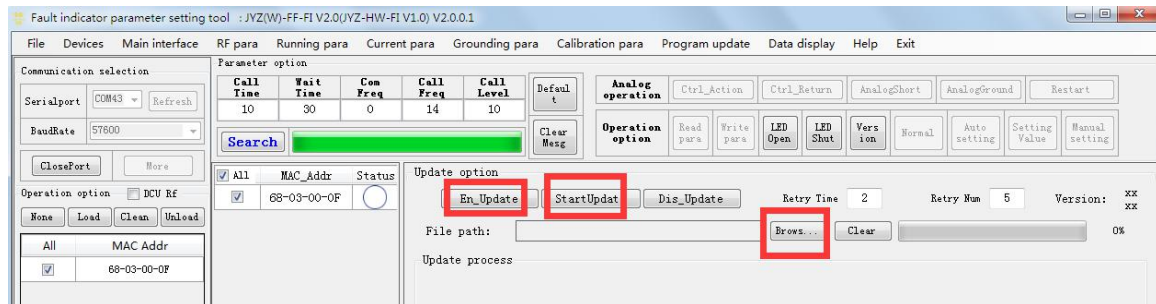

Before Updating

At last, click “StartUpdate” button and wait until the progress bar reaches 100% and the Status shows “OK”, and the update operation finished.

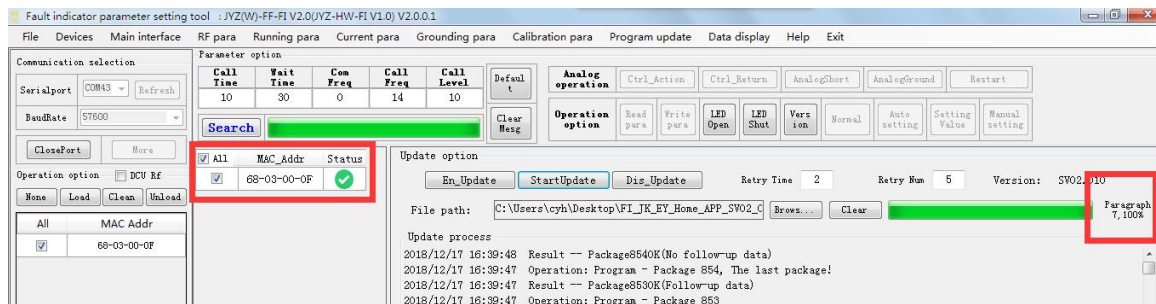

5.2 DCU Upgrading

- 1) Disconnect the Power of DCU, connect RS232 connector and PC USB with cable
- 2) Run the SW tool “DtuDownload”

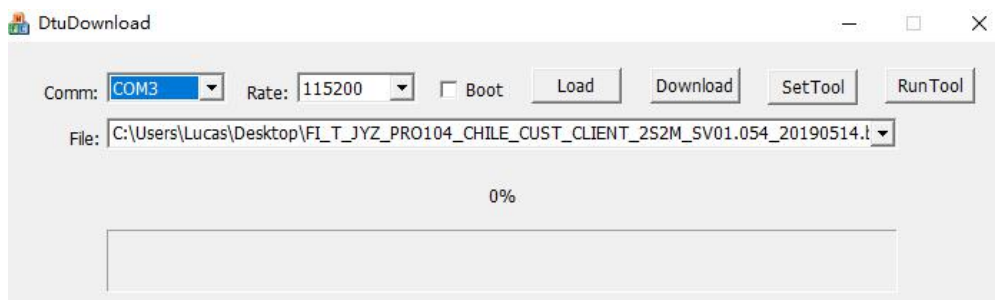

- 3) Select correct COM and Baudrate

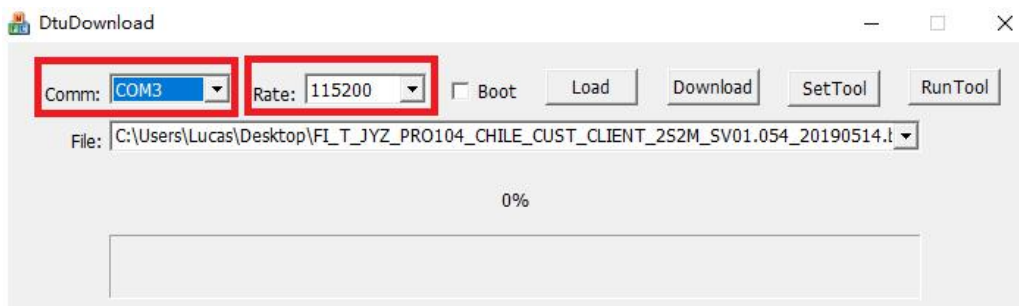

- 4) Click “Load ” to select the firmware

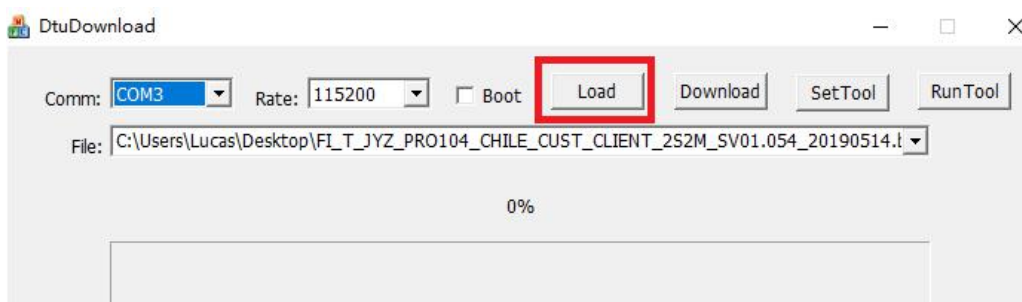

- 5) Click “Download” to download the SW from PC

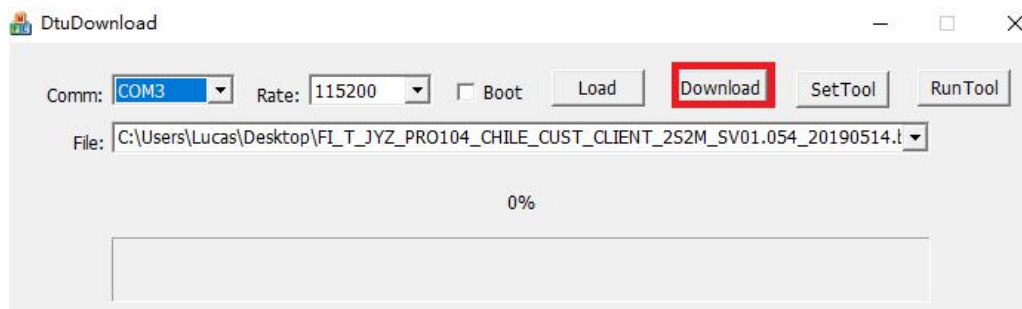

6) Connect the power of DCU. Then you could check the upgrade process run to 100%. That means the upgrade is successful.

6 Dimensions

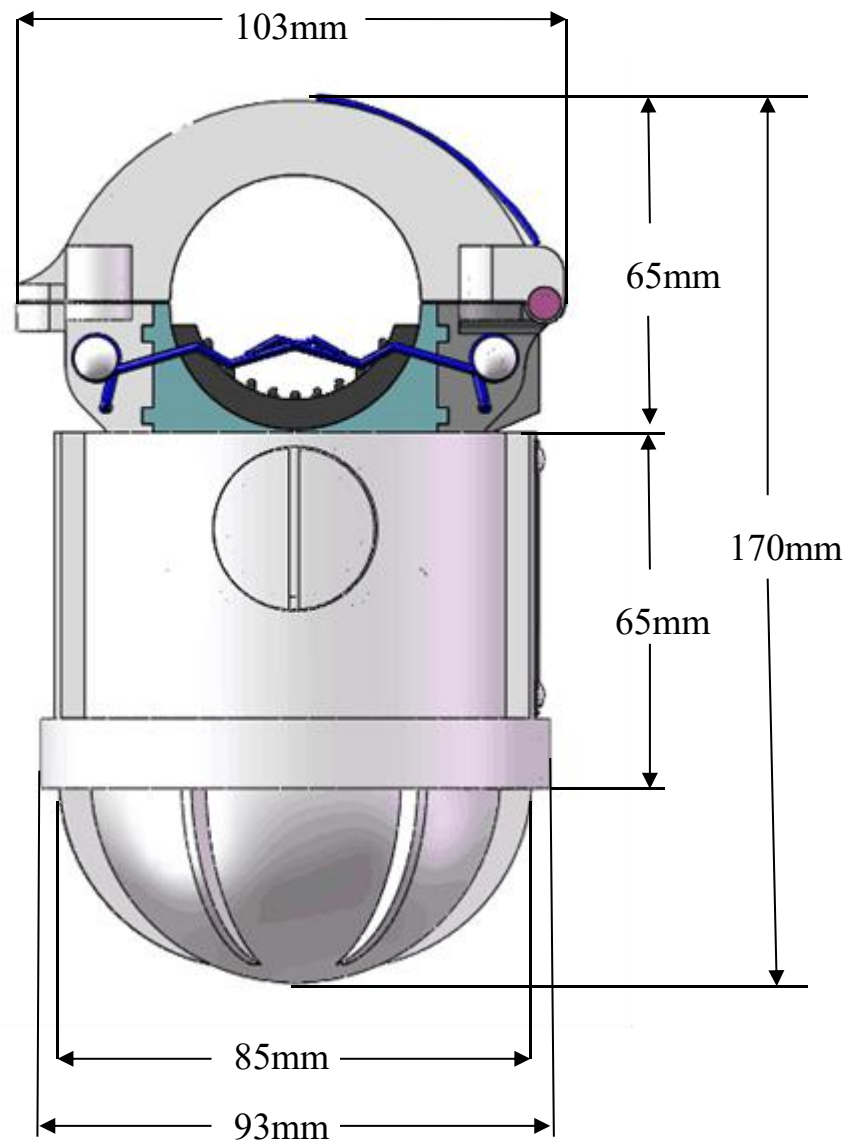

7 Mounting and Dismounting Instruction

7.1 Mounting

Before installation in the field

Reconfirm the communication parameters configuration of indicators and DCU before the installation in the field, such as group address, frequency, IP address, and port. And make sure the SIM card is in service and insert correctly.

Mounting

The indicators are mounted onto the overhead line with a special hot-stick installation tool (picture a).

First of all, put the indicator into the drum, and open the split coil CT with thumb and fix it (picture b). Secondly upwarp the spring with tool and fix them (picture c, d). Position the conductor between the open split coil CT, and with a forceful upward movement, install the indicator to the overhead line (picture e). When the indicator receives sufficient pressure, the spring will release and clamping the line, and the installation tool will separate from the indicator (picture f).



Picture (a)



Picture (b)

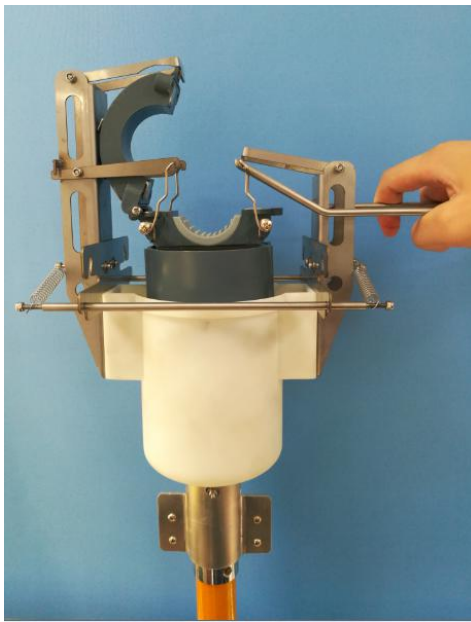

Picture (c)



Picture (d)

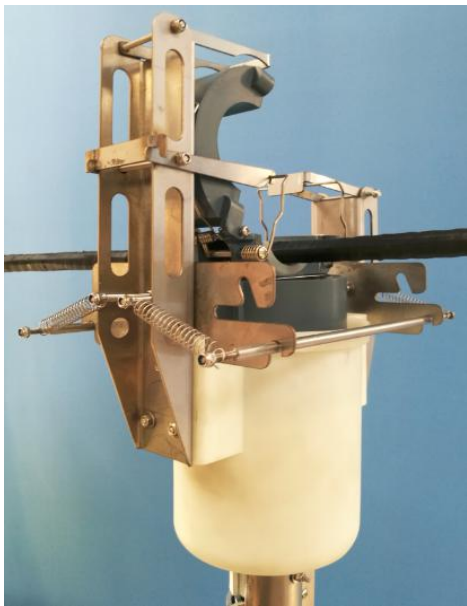

Picture (e)



Picture (f)

Note:

The DCU is mounted on the pole, typically 3 meters below the lines and 2.5 meters up to the ground. The solar panel should point to the direction of the sun, to make sure the sun shines most of daylight to the panel.

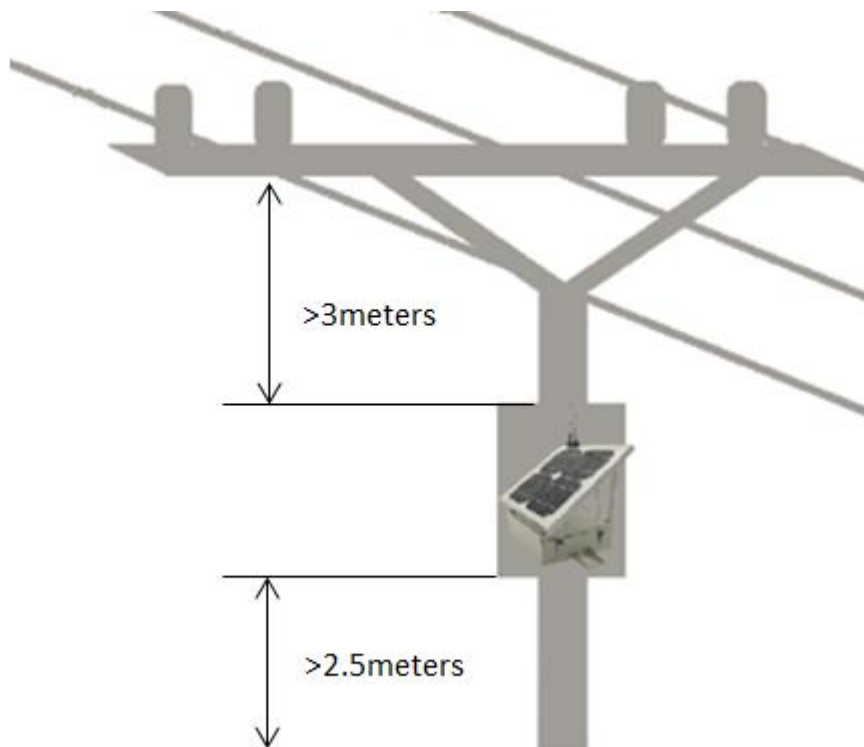

7.2 Dismounting

1) Place the small iron rods on both sides in the position shown in below picture



2) Put the tool into indicator and push the tool upwards

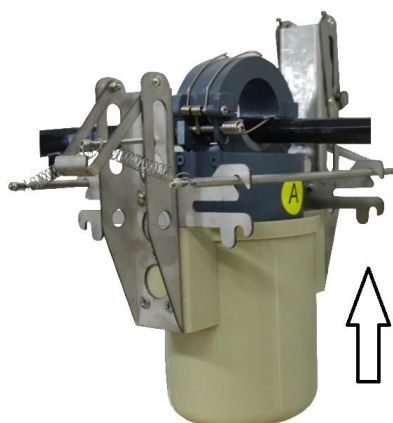

3) Then, the small iron rod will be stuck on the body of indicator



4) Pull the tool down, and the wire will detach from the spring of indicator

