

F3X46 Series User Manual	Product Version	Page
	V1.0	
	Product Name: F3X46	Total:86

F3X46 Series User Manual

The user manual is suitable for the following model:

Model	Product Type
F3446	WCDMA Dual-SIM WIFI ROUTER
F3746	LTE/TD-SCDMA Dual-SIM WIFI ROUTER
F3846	LTE/WCDMA Dual-SIM WIFI ROUTER
F3A46	LTE Dual-SIM WIFI ROUTER



Four-Faith Smart Power Technology Co., Ltd.

Add : Floor 11, Area A06, No 370, chengyi street, Jimei, Xiamen, China

Zip Code:361008

Tel : +86+17750019379

Email:Business@four-faith.com

Website: <http://en.four-faith.net>



Files Revised Record

Date	Version	Remark	Author
2015.09.05	V1.0	First created	PF

Copyright Notice

All contents in the files are protected by copyright law, and all copyrights are reserved by Xiamen Four-Faith Communication Technology Co., Ltd. Without written permission, all commercial use of the files from Four-Faith are forbidden, such as copy, distribute, reproduce the files, etc., but non-commercial purpose, downloaded or printed by individual (all files shall be not revised, and the copyright and other proprietorship notice shall be reserved) are welcome.

Trademark Notice

Four-Faith、四信、、、 are all registered trademarks of Xiamen Four-Faith Communication Technology Co., Ltd., illegal use of the name of Four-Faith, trademarks and other marks of Four-Faith is forbidden, unless written permission is authorized in advance.



Contents

Contents.....	5
Chapter 1 Brief Introduction of Product.....	7
1.1 General.....	7
1.2 Features and Benefits.....	7
1.3 Working Principle.....	8
1.4 Specifications.....	9
Chapter 2 Installation Introduction.....	12
2.1 General.....	12
2.2 Encasement List.....	12
2.3 Installation and Cable Connection.....	12
2.4 Power.....	15
2.5 Indicator Lights Introduction.....	15
2.6 Reset Button Introduction.....	16
Chapter 3 Configuration and Management.....	17
3.1 Configuration Connection.....	17
3.2 Access the Configuration Web Page.....	17
3.3 Management and configuration.....	19
3.3.1 Setting.....	19
3.3.1.1 Basic Setting.....	19
3.3.1.2 Dynamic DNS.....	25
3.3.1.3 Clone MAC Address.....	26
3.3.1.4 Advanced Router.....	27
3.3.1.5 VLANs.....	28
3.3.1.6 Networking.....	29
3.3.2 Wireless.....	32
3.3.2.1 Basic Settings.....	32
3.3.2.2 Wireless Security.....	34
3.3.3 Services.....	36
3.3.3.1 Services.....	36
3.3.4 VPN.....	40
3.3.4.1 PPTP.....	40
3.3.4.2 L2TP.....	41
3.3.4.3 OPENVPN.....	42
3.3.4.4 IPSEC.....	47
3.3.4.5 GRE.....	49
3.3.5 Security.....	50
3.3.5.1 Firewall.....	50
3.3.6 Access Restrictions.....	53
3.3.6.1 WAN Access.....	53
3.3.6.2 Packet Filter.....	55
3.3.7 NAT.....	56
3.3.7.1 Port Forwarding.....	56

3.3.7.2 Port Range Forward.....	57
3.3.7.3 DMZ.....	57
3.3.8 QoS Setting.....	58
3.3.8.1 Basic.....	58
3.3.8.2 Classify.....	59
3.3.9 Applications.....	59
3.3.9.1 Serial Applications.....	59
3.3.10 Administration.....	60
3.3.10.1 Management.....	60
3.3.10.2 Keep Alive.....	62
3.3.10.3 Commands.....	63
3.3.10.4 Factory Defaults.....	64
3.3.10.5 Firmware Upgrade.....	64
3.3.10.6 Backup.....	65
3.3.11 Status.....	65
3.3.11.1 Router.....	65
3.3.11.2 WAN.....	67
3.3.11.3 BKUP WAN.....	69
3.3.11.4 LAN.....	71
3.3.11.5 Wireless.....	74
3.3.11.6 Bandwidth.....	75
3.3.11.7 Sys-Info.....	77
Chapter 4 Appendix.....	80

Chapter 1 Brief Introduction of Product

1.1 General

F3X46 series ROUTER is a kind of cellular terminal device that provides data transfer function by public cellular network. Also, it supports double link backup function

It adopts high-powered industrial 46-bits CPU and embedded real time operating system. It supports RS232 (or RS485/RS422), Ethernet and WIFI port that can conveniently and transparently connect one device to a cellular network, allowing you to connect to your existing serial, Ethernet and WIFI devices with only basic configuration.

It has been widely used on M2M fields, such as intelligent transportation, smart grid, industrial automation, telemetry, finance, POS, water supply, environment protection, post, weather, and so on.

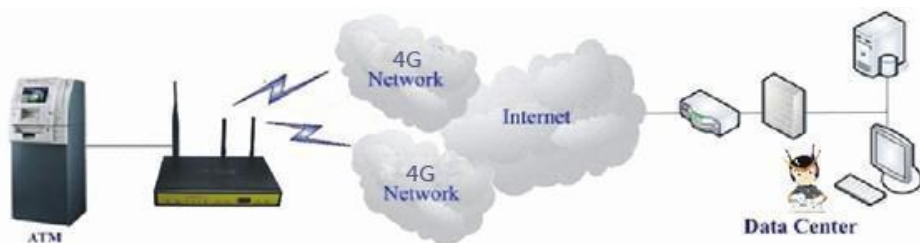

1.2 Features and Benefits

Design for Industrial Application

- ◆ High-powered industrial cellular module
- ◆ High-powered industrial 46bits CPU
- ◆ Adapt dual sim design to ensure the stable and reliable of the router
- ◆ Support low-consumption mode, including sleep mode, scheduled online/offline mode, scheduled power-on/power-off mode(optional)
- ◆ Housing: iron, providing IP30 protection.
- ◆ Power range: DC 5~36V

Stability and Reliability

- ◆ Support hardware and software WDT
- ◆ Support auto recovery mechanism, including online detect, auto redial when offline to make router always online
- ◆ Ethernet port: 1.5KV magnetic isolation protection
- ◆ RS232/RS485/RS422 port: 15KV ESD protection
- ◆ SIM/UIM port: 15KV ESD protection
- ◆ Power port: reverse-voltage and overvoltage protection
- ◆ Antenna port: lightning protection(optional)

Standard and Convenience

- ◆ Support standard RS232(or RS485/RS422), Ethernet and WIFI port that can connect to serial,

Ethernet and WIFI devices directly

- ◆ Support standard WAN port and PPPOE protocol that can connect to ADSL directly
- ◆ Support intellectual mode, enter into communication state automatically when powered
- ◆ Provide management software for remote management
- ◆ Support several work modes
- ◆ Convenient configuration and maintenance interface (WEB or CLI)

High-performance

- ◆ Support master card and smart card double link switching function
- ◆ Support double link backup between 3G/4G and WAN(PPPOE, ADSL) (optional)
- ◆ Support VPN client(PPTP, L2TP, OPENVPN, IPSEC and GRE)(only for VPN version)
- ◆ Support VPN server(PPTP, L2TP, OPENVPN, IPSEC and GRE)(only for VPN version)
- ◆ Support local and remote firmware upgrade,import and export configure file.
- ◆ Support NTP, RTC embedded.
- ◆ Support multiple DDNS provider service.
- ◆ Support VLANs, MAC Address clone, PPPoE Server
- ◆ WIFI support 802.11b/g/n. support AP, client, Adhoc, Repeater, Repeater Bridge and WDS(optional) mode.
- ◆ WIFI support WEP,WPA,WPA2 encryption,Support RADIUS authentication and MAC address filter.
- ◆ Support multi online trigger ways, including SMS, ring and data. Support link disconnection when timeout
- ◆ Support APN/VPDN
- ◆ Support DHCP server and client, firewall, NAT, DMZ host , URL block, QoS, ttraff,statistics, real time link speed statistics etc.
- ◆ Full protocol support , such as TCP/IP, UDP, ICMP, SMTP, HTTP, POP3, OICQ, TELNET, FTP, SNMP, SSHD, etc.
- ◆ Schedule Reboot, Schedule Online and Offline,etc.

1.3 Working Principle

The principle chart of the router is as following:

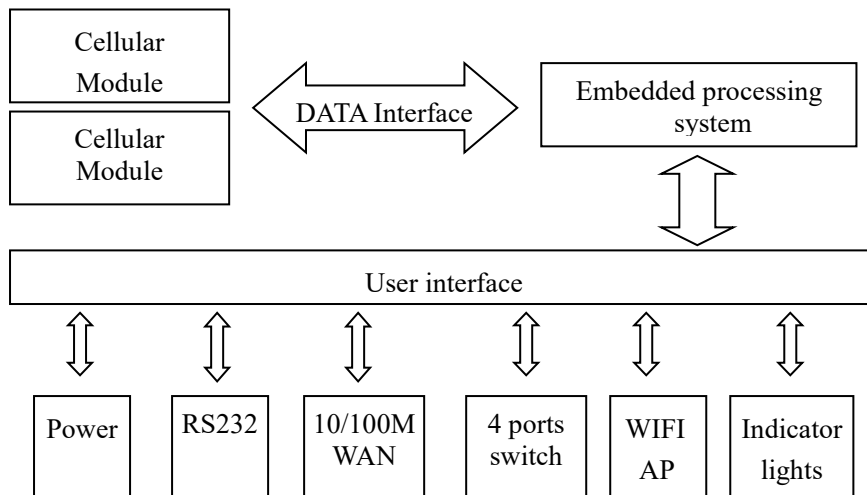

1.4 Specifications

Cellular Specification

ITEM	CONTENT
F3446 WCDMA WIFI Router	
Standard and Band	UMTS/WCDMA/HSDPA/HSUPA /HSPA+ 850/1900/2100MHz 850/900/1900/2100MHz(optional) GSM850/900/1800/1900MHz GPRS/EDGE CLASS 12
Bandwidth	HSUPA:5.76Mbps(Upload speed) HSDPA:7.2Mbps(Download speed) UMTS:384Kbps (DL/UL) HSPA+:21 Mbps(Download speed) 5.76Mbps (Upload speed)
TX power	<24dBm
RX sensitivity	<-109dBm
F3746 LTE/TD-SCDMA+WIFI Router	
Standard and Band	LTE TDD 2600/1900/2300MHz (Band 38/39/40) 800/1400/1800MHz(Band27/61/62) (optional) TD-SCDMA 2010/1900MHz (A/F frequency band, Band 34/39) GSM/GPRS/EDGE 900/1800/1900MHz
Bandwidth	LTE TDD(Download speed:68Mbps, upload speed:17Mbps) TD-SCDMA :2.2Mbps(upload speed)/2.8Mbps(download speed)
TX power	<23dBm
RX sensitivity	<-97dBm
F3846 LTE/WCDMA+WIFI Router	
Standard and Band	LTE FDD 2600/2100/1800/900/800MHz (Band 1/3/7/8/20) 700/850/1700/1900/2100MHz (Band 2/4/5/13/17/25)(optional) DC-HSPA+/HSPA+/HSDPA/HSUPA/WCDMA/UMTS 2100/1900/900/850/800MHz(Band 1/2/5/6/8) EDGE/GPRS/GSM850/900/1800/1900MHz
Bandwidth	LTE FDD(Download speed:100Mbps, upload speed:50Mbps) HSUPA:5.76Mbps(upload speed) HSDPA:7.2Mbps(download speed:) UMTS:384Kbps (download speed/upload speed) HSPA+: 42Mbps(download speed) 5.76Mbps(upload speed)
TX power	<23dBm
RX sensitivity	<-93.3dBm
F3A46 LTE+WIFI Router	
Standard and Band	TDD-LTE、FDD-LTE、EVDO、WCDMA、TD-SCDMA、CDMA1X、 GPRS/EDGE
Bandwidth	FDD LTE(Download speed:100Mbps, upload speed:50Mbps) TDD LTE(Download speed:68Mbps, upload speed:17Mbps) CDMA2000 1X EVDO Rev A (Download speed:3.1Mbps, upload speed:1.8Mbps)

	WCDMA(Download speed:42Mbps, upload speed:5.76Mbps) TD-SCDMA(Download speed:4.2Mbps, upload speed:2.2Mbps)
TX power	<23dBm
RX sensitivity	<-93.3dBm

WIFI Specification

Item	Content
Standard	IEEE802.11b/g/n
Bandwidth	IEEE802.11b/g: 54Mbps (max) IEEE802.11n: 150Mbps (max)
Security	WEP, WPA, WPA2, etc. WPS (optional)
TX power	20dBm (11n), 24dBm (11g), 26dBm (11b)
RX sensitivity	<-72dBm@54Mbps

Hardware System

Item	Content
CPU	Industrial 32bits CPU
FLASH	16MB(Extendable to 64MB)
DDR2	128MB

Interface Type

Item	Content
WAN	1 10/100 Mbps WAN port(RJ45), auto MDI/MDIX, 1.5KV magnetic isolation protection
LAN	4 10/100 Mbps Ethernet ports(RJ45), auto MDI/MDIX, 1.5KV magnetic isolation protection
Serial	1 RS232(or RS485/RS422) port, 15KV ESD protection Data bits: 5, 6, 7, 8 Stop bits: 1, 1.5(optional), 2 Parity: none, even, odd, space(optional), mark(optional) Baud rate: 2400~115200 bps
Indicator	"Power", "System", "Online-1", "Online-2", " Local Network ", "WAN", "WIFI", "Signal Strength"
Antenna	Cellular:2 Standard SMA female interface, 50 ohm, lightning protection(optional) WIFI: 1 Standard SMA male interface, 50 ohm, lightning protection(optional)
SIM/UIM	Standard 3V/1.8V user card interface, 15KV ESD protection
Power	Standard 3-PIN power jack, reverse-voltage and overvoltage protection
Reset	Restore the router to its original factory default settings





Power Input

Item	Content
Standard Power	DC 12V/1.5A
Power Range	DC 5~36V

Consumption

Working condition	Consumption
Schedule shutdown	2.57~4.2mA@12DVC
F3436 WCDMA ROUTER	
Standby	272~295mA@12VDC
Communication	283~360mA@12VDC
F3736 LTE/TD-SCDMA ROUTER	
Standby	281~328mA@12VDC
Communication	322~563mA@12VDC
F3836 LTE/WCDMA ROUTER	
Standby	280~330mA@12VDC
Communication	325~562mA@12VDC
F3A36 LTE ROUTER	
Standby	293~326mA@12VDC
Communication	310~554mA@12VDC

Physical Characteristics

Item	Content
Housing	Iron, providing IP30 protection
Dimensions	206x135x28 mm
Weight	790g

Environmental Limits

Item	Content
Operating Temperature	-35~+75°C (-31~+167°F)
Storage Temperature	-40~+85°C (-40~+185°F)
Operating Humidity	95% (Non-condensing)

Chapter 2 Installation Introduction

2.1 General

The router must be installed correctly to make it work properly.

Warning: Forbid to install the router when powered!

2.2 Encasement List

Name	Quantity	Remark
Router host	1	
Cellular antenna (Male SMA)	2	
WIFI antenna (Female SMA)	1	
Network cable	1	
Console cable	1	optional
Power adapter	1	
Manual CD	1	
Certification card	1	
Maintenance card	1	

2.3 Installation and Cable Connection

Stator and routing equipment of screw specification for: M3 * 5 mm countersunk head screws (black)

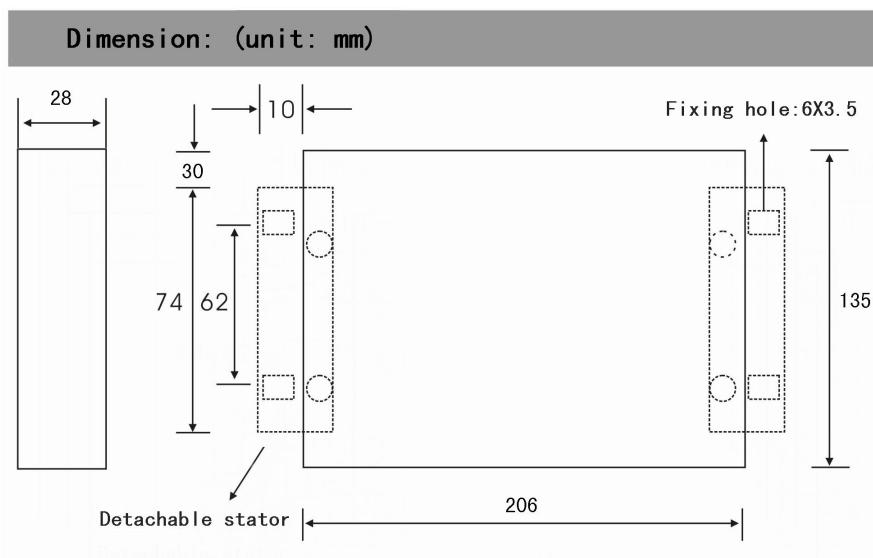

Installation of SIM/UIM card:

SIM/UIM-1: For the main link

SIM/UIM-2: For the backup link

Firstly power off the router, and press the out button of the SIM/UIM card outlet with a needle object. Then the SIM/UIM card sheath will flick out at once. Put SIM/UIM card into the card sheath (Pay attention to put the side which has metal point outside), and insert card sheath back to the SIM/UIM card outlet.

Warning: Forbid to install SIM/UIM card when powered!

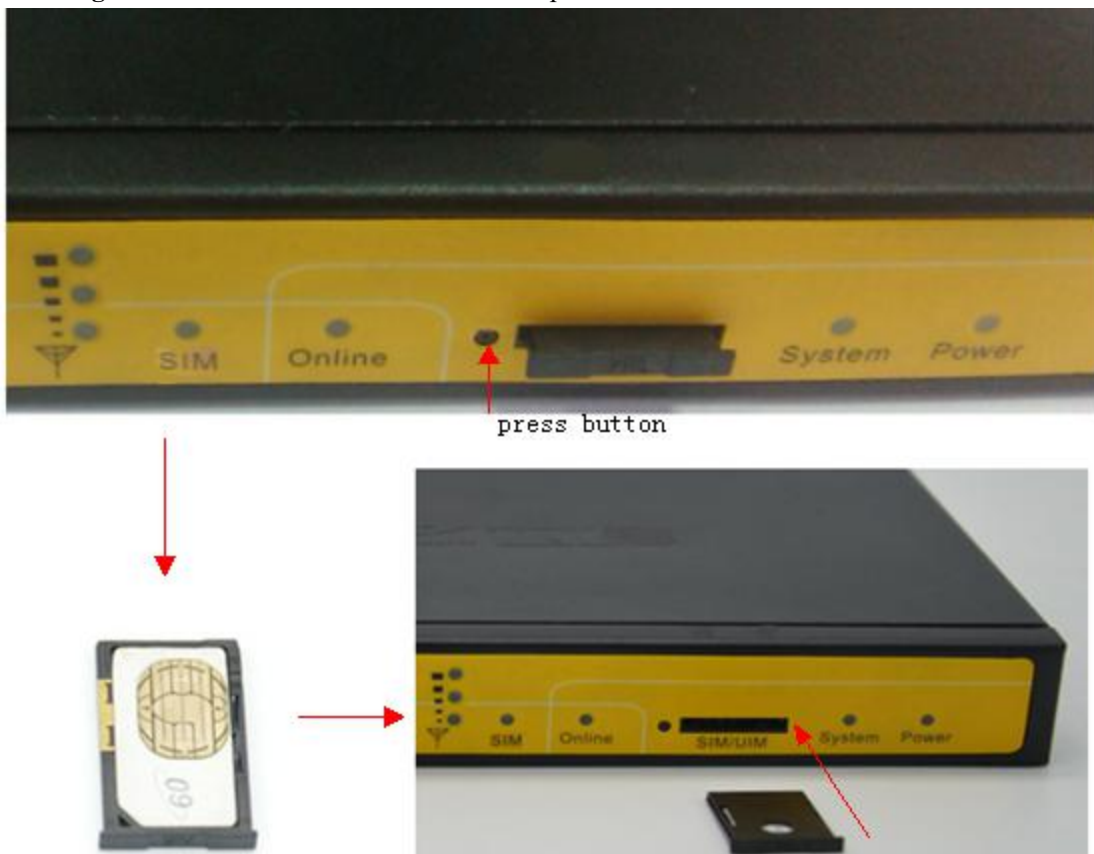

Installation of antenna:

Screw the SMA male pin of the cellular antenna to the female SMA interface of the router with sign “ANT”.

Screw the SMA female pin of the WIFI antenna to the male SMA interface of the router with sign “WIFI”.

Warning: The cellular antenna and the WIFI antenna can not be connected wrongly. And the antennas must be screwed tightly, or the signal quality of antenna will be influenced!

Installation of cable:

Insert one end of the network cable into the switch interface with sign “Local Network”, and insert the other end into the Ethernet interface of user’s device. The signal connection of network direct cable is as follows:

RJ45-1	RJ45-2
1	1
2	2
3	3
4	4
5	5
6	6
7	7
8	8



Insert the RJ45 end of the console cable into the RJ45 outlet with sign “console”, and insert the DB9F end of the console cable into the RS232 serial interface of user’s device.

The signal connection of the console cable is as follows:

RJ45	DB9F
1	8
2	6
3	2
4	1
5	5
6	3
7	4
8	7

The signal definition of the DB9F serial communication interface is as follows:

Pin	RS232 signal name	The direction for Router
1	DCD	output
2	RXD	output
3	TXD	input
4	DTR	input
5	GND	
6	DSR	output
7	RTS	input
8	CTS	output



2.4 Power

The power range of the router is DC 5~35V.

Warning: When we use other power, we should make sure that the power can supply power above 8W.

We recommend user to use the standard DC 12V/1.5A power.

2.5 Indicator Lights Introduction

The router provides following indicator lights: “Power”, “System”, "Online-1", "Online-2", “Local Network”, “WAN”, “WIFI”, “Signal Strength”.

Indicator Light	State	Introduction
Power	ON	Router is powered on
	OFF	Router is powered off

System	BLINK	System works properly
	OFF	System does not work
Online-1	ON	The main link has logged on network
	OFF	The main link hasn't logged on network
Online-2	ON	The backup link has logged on network
	OFF	The backup link hasn't logged on network
Local Network	OFF	The corresponding interface of switch is not connected
	ON / BLINK	The corresponding interface of switch is connected /Communicating
WAN	OFF	The interface of WAN is not connected
	ON / BLINK	The interface of WAN is connected /Communicating
WIFI	OFF	WIFI is not active
	ON	WIFI is active
Signal Strength	One Light ON	Signal strength is weak
	Two Lights ON	Signal strength is medium
	Three Lights ON	Signal strength is good

2.6 Reset Button Introduction

The router has a “Reset” button to restore it to its original factory default settings. When user press the “Reset” button for up to 15s, the router will restore to its original factory default settings and restart automatically.

Chapter 3 Configuration and Management

This chapter describes how to configure and manage the router.

3.1 Configuration Connection

Before configuration, you should connect the router and your configuration PC with the supplied network cable. Plug the cable's one end into the Local Network port of the router, and another end into your configure PC's Ethernet port. The connection diagram is as following:

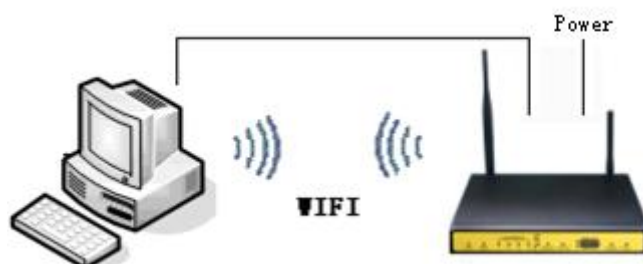

Please modify the IP address of PC as the same network segment address of the router, for instance, 192.168.1.9. Modify the mask code of PC as 255.255.255.0 and set the default gateway of PC as the router's IP address (192.168.1.1).

3.2 Access the Configuration Web Page

The chapter is to present main functions of each page. Users visit page tool via web browser after connect users' PC to the router. There are eleven main pages: Setting, Wireless, Service, VPN, Security, Access Restrictions, NAT, QoS Setting, Applications, Management and Status. Users enable to browse slave pages by click one main page.

Users can open IE or other explorers and enter the router's default IP address of 192.168.1.1 on address bar, then press the botton of Enter to visit page Web management tool of the router. The users login in the web page at the first name, there will display a page shows as blow to tip users to modify the default user name and password of the router. Users have to click "change password" to make it work if they modify user name and password.

Router Management

Your Router is currently not protected and uses an unsafe default username and password combination, please change it using the following dialog!

Router Password

Router Username:

Router Password:

Re-enter to confirm:

After access to the information main page

Menu

- [Setup](#)
- [Wireless](#)
- [Services](#)
- [VPN](#)
- [Security](#)
- [NAT](#)
- [Access Restrictions](#)
- [QoS Setting](#)
- [Applications](#)
- [Administration](#)
- [Status](#)

System Information

Router

Router Name	Router
Router Model	Four-Faith Router
LAN MAC	00:0C:43:F3:39:BA
WAN MAC	00:0C:43:F3:39:BB
Wireless MAC	00:0C:43:F3:39:BC
WAN IP	0.0.0.0
BKUP WAN IP	0.0.0.0
LAN IP	192.168.1.1

Services

DHCP Server	Enabled
ff-radauth	Disabled
USB Support	Enabled

Wireless

Radio	Radio is On
Mode	AP
Network	Mixed
SSID	ssid
Channel	6 (2437 MHz)
TX Power	71 mW
Rate	72 Mb/s

Wireless Packet Info

Received (RX)	14393 OK, no error
Transmitted (TX)	105 OK, no error

Wireless Clients

MAC Address	Interface	Uptime	TX Rate	RX Rate	Signal	Noise	SNR	Signal Quality
- None -								

DHCP

[DHCP Client](#)

Users need to input user name and password if it is their first time to login.



Input correct user name and password to visit relevant menu page. Default user name is root, password is admin. (available to modify user name and password on management page, then click submit)

3.3 Management and configuration

3.3.1 Setting

The Setup screen is the first screen users will see when accessing the router. Most users will be able to configure the router and get it work properly using only the settings on this screen. Some Internet Service Providers (ISPs) will require users to enter specific information, such as User Name, Password, IP Address, Default Gateway Address, or DNS IP Address. These information can be obtained from your ISP, if required.

3.3.1.1 Basic Setting

DUAL LINK OPTION



Enable dual link option to enable dual both online router. Click disable means to enable only single link (main link), and backup link does not enable to work. Click enable means to only one link can work between main link and backup link. If main link is online, it uses main link. If main link is offline, it switches to backup link. Only backup link is offline can it switch to main link.

Note: when users enable dual link option, they need to configure relevant keep online function if connection type of main link and backup link is 'Static IP' or 'DHCP'. Detailed configuration refer to Keep Online section. Connection type of main link and backup link forbid to be the same, and not under the same Ethernet port. For example, main link is 'Static IP', 'DHCP', or 'PPPOE', backup link must be 3G Link 1 or 3G Link 2, otherwise the page will appear corresponding hint.

Connection Type

Seven Ways: Disabled, Static IP, Automatic Configuration-DHCP, PPPOE, 3G Link 1, 3G Link 2, DHCP-4G

Disabled

Connection Type

Forbid the setting of WAN port connection type

Static IP

Connection Type

WAN IP Address

Subnet Mask

Gateway

Static DNS 1

Static DNS 2

Static DNS 3

WAN IP Address: Users set IP address by their own or ISP assigns

Subnet Mask: Users set subnet mask by their own or ISP assigns

Gateway: Users set gateway by their own or ISP assigns

Static DNS1/DNS2/DNS3: Users set static DNS by their own or ISP assigns

Automatic Configuration-DHCP

Connection Type

IP address of WAN port gets automatic via DHCP

PPPOE

Connection Type

User Name

Password Unmask

User Name: login the Internet

Password: login the Internet

Service Name: provided by ISP server, if not, keep it null

PPP Compression (MPPC): provides a method to negotiation and use of compressed in PPP encapsulation link protocol

T-Home VDSL VLAN 7/8 Tagging: enable to support the front of the modem is vdsl

MPPE Encryption: Microsoft point to point encryption. It is used to encrypt the point-to-point link connection agreement of the encrypted data packet

Single Line Multi Link: enable single line link or disable multi link

3G Link 1

Connection Type	<input type="text" value="3G/UMTS/4G/LTE"/>	
User Name	<input type="text"/>	
Password	<input type="text"/>	<input type="checkbox"/> Unmask
Dial String	<input type="text" value="*99***1# (UMTS/3G/3.5G)"/>	
APN	<input type="text"/>	
PIN	<input type="text"/>	<input type="checkbox"/> Unmask

User Name: login users' ISP(Internet Service Provider)

Password: login users' ISP

Dial String: dial number of users' ISP

APN: access point name of users' ISP

PIN: PIN code of users' SIM card

3G Link 2

Connection Type	<input type="text" value="3G/UMTS/4G/LTE"/>	
User Name	<input type="text"/>	
Password	<input type="text"/>	<input type="checkbox"/> Unmask
Dial String	<input type="text" value="*99***1# (UMTS/3G/3.5G)"/>	
APN	<input type="text"/>	
PIN	<input type="text"/>	<input type="checkbox"/> Unmask

User Name: login users' ISP(Internet Service Provider)

Password: login users' ISP

Dial String: dial number of users' ISP

APN: access point name of users' ISP

PIN: PIN code of users' SIM card

Connection type

Connection type Auto

Connection type: Auto, Force 3G, Force 2G, Prefer 3G, Prefer 2G options. If using 4G module, there has 4G network option. Users select different mode depending on their need

DHCP-4G

Connection Type dhcp-4G

IP address of WAN port gets automatic via DHCP-4G

Keep Online

Keep Online Detection Ping

Detection Interval 60 Sec.

Primary Detection Server IP 166 . 111 . 8 . 238

Backup Detection Server IP 202 . 119 . 32 . 102

This function is used to detect whether the Internet connection is active, if users set it and when the router detect the connection is inactive, it will redial to users' ISP immediately to make the connection active.

Detection Method:

None: do not set this function

Ping: Send ping packet to detect the connection, when choose this method, users should also configure "Detection Interval", "Primary Detection Server IP" and "Backup Detection Server IP" items.

Route: Detect connection with route method, when choose this method, users should also configure "Detection Interval", "Primary Detection Server IP" and "Backup Detection Server IP" items.

PPP: Detect connection with PPP method, when choose this method, users should also configure "Detection Interval" item.

Detection Interval: time interval between two detections, unit is second

Primary Detection Server IP: the server used to response the router's detection packet. This item is only valid for method "Ping" and "Route".

Backup Detection Server IP: the server used to response the router's detection packet. This item is valid for method "Ping" and "Route".

Note: When users choose the "Route" or "Ping" method, it's quite important to make sure that the "Primary Detection Server IP" and "Backup Detection Server IP" are usable and stable, because they have to response the detection packet frequently.

Force reconnect Enable Disable

Time 00 : 00

Force reconnect: this option schedules the pppoe or 3G reconnection by killing the pppd daemon and restart it.

Time: needed time to reconnect

Enable Dial Failure to Restart Enable Disable (Default: 10 minutes)

Enable Dial Failure to Restart: If the dial failure will be in the default time to restart

STP

STP Enable Disable

STP (Spaning Tree Protocol) can be applied to loop network. Through certain algorithm achieves path redundancy, and loop network cuts to tree-based network without loop in the meantime, thus to avoid the hyperplasia and infinite circulation of a message in the loop network

Optional Configuration

Router Name	Four-Faith
Host Name	
Domain Name	
MTU	Auto <input type="button" value="v"/> 1500

Router Name: set router name

Host Name: ISP provides

Domain Name: ISP provides

MTU: auto (1500) and manual (1200-1492 in PPPOE/PPTP/L2TP mode, 576-16460 in other modes)

Router Internal Network Settings

Router IP

Local IP Address	192	.	168	.	1	.	1
Subnet Mask	255	.	255	.	255	.	0
Gateway	0	.	0	.	0	.	0
Local DNS	0	.	0	.	0	.	0

Local IP Address: IP address of the router

Subnet Mask: the subnet mask of the router

Gateway: set internal gateway of the router. If default, internal gateway is the address of the router

Local DNS: DNS server is auto assigned by network operator server. Users enable to use their own DNS server or other stable DNS servers, if not, keep it default

Network Address Server Settings (DHCP)

These settings for the router's Dynamic Host Configuration Protocol (DHCP) server functionality configuration. The Router can serve as a network DHCP server. DHCP server automatically assigns an IP address for each computer in the network. If they choose to enable the router's DHCP server option, users can set all the computers on the LAN to automatically obtain an IP address and DNS, and make sure no other DHCP server in the network.

DHCP Type	<input type="text" value="DHCP Server"/>
DHCP Server	<input checked="" type="radio"/> Enable <input type="radio"/> Disable
Start IP Address	192.168.1. <input type="text" value="100"/>
Maximum DHCP Users	<input type="text" value="50"/>
Client Lease Time	<input type="text" value="1440"/> minutes
Static DNS 1	<input type="text" value="0"/> . <input type="text" value="0"/> . <input type="text" value="0"/> . <input type="text" value="0"/>
Static DNS 2	<input type="text" value="0"/> . <input type="text" value="0"/> . <input type="text" value="0"/> . <input type="text" value="0"/>
Static DNS 3	<input type="text" value="0"/> . <input type="text" value="0"/> . <input type="text" value="0"/> . <input type="text" value="0"/>
WINS	<input type="text" value="0"/> . <input type="text" value="0"/> . <input type="text" value="0"/> . <input type="text" value="0"/>
Use DNSMasq for DHCP	<input checked="" type="checkbox"/>
Use DNSMasq for DNS	<input checked="" type="checkbox"/>
DHCP-Authoritative	<input checked="" type="checkbox"/>

DHCP Type: DHCP Server and DHCP Forwarder

Enter DHCP Server if set DHCP Type to DHCP Forwarder as blow:

DHCP Type	<input type="text" value="DHCP Forwarder"/>
DHCP Server	<input type="text" value="0"/> . <input type="text" value="0"/> . <input type="text" value="0"/> . <input type="text" value="0"/>

DHCP Server: keep the default Enable to enable the router's DHCP server option. If users have already have a DHCP server on their network or users do not want a DHCP server, then select Disable

Start IP Address: enter a numerical value for the DHCP server to start with when issuing IP addresses. Do not start with 192.168.1.1 (the router's own IP address).

Maximum DHCP Users: enter the maximum number of PCs that users want the DHCP server to assign IP addresses to. The absolute maximum is 253 if 192.168.1.2 is users' starting IP address.

Client Lease Time: the Client Lease Time is the amount of time a network user will be allowed connection to the router with their current dynamic IP address. Enter the amount of time, in minutes, that the user will be "leased" this dynamic IP address.

Static DNS (1-3): the Domain Name System (DNS) is how the Internet translates domain or website names into Internet addresses or URLs. Users' ISP will provide them with at least one DNS Server IP address. If users wish to utilize another, enter that IP address in one of these fields. Users can enter up to three DNS Server IP addresses here. The router will utilize them for quicker access to functioning DNS servers.

WINS: the Windows Internet Naming Service (WINS) manages each PC's interaction with the Internet. If users use a WINS server, enter that server's IP address here. Otherwise, leave it blank.

DNSMasq: users' domain name in the field of local search, increase the expansion of the host option, to adopt DNSMasq can assign IP addresses and DNS for the subnet, if select DNSMasq, dhcpd service is used for the subnet IP address and DNS.

Time Settings

Select time zone of your location. To use local time, leave the checkmark in the box next to Use local time.



The screenshot shows the 'Time Settings' configuration page. It includes the following fields and options:

- NTP Client:** A radio button group with 'Enable' selected and 'Disable' unselected.
- Time Zone:** A dropdown menu currently set to 'UTC+08:00'.
- Summer Time (DST):** A dropdown menu currently set to 'last Sun Mar - last Sun Oct'.
- Server IP/Name:** An empty text input field.

NTP Client: Get the system time from NTP server

Time Zone: Time zone options

Summer Time (DST): set it depends on users' location

Server IP/Name: IP address of NTP server, up to 46 characters. If blank, the system will find a server by default

Adjust Time

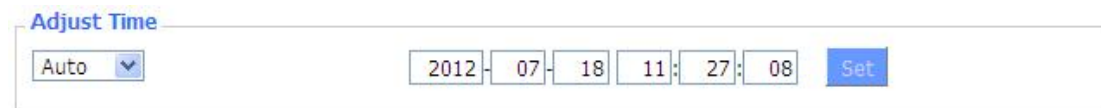

The screenshot shows the 'Adjust Time' configuration page. It includes the following elements:

- Adjust Time:** A section header.
- Auto:** A dropdown menu currently set to 'Auto'.
- Time:** A digital clock display showing '2012-07-18 11:27:08'.
- Set:** A blue button to confirm the time adjustment.

Adjust Time : Auto and Manual way. Manual way needs to enter the time. Auto way is to get the time from PC web, click the bottom of setting to modify system time, has system adjust time service. They can change to adjust time by manual to achieve adjust time by the system if the system fails to get NTP server

After modify, click '**Save**' is to change but not take effect, click '**Apply Setting**' to take effect the change or click '**Cancel Changes**' to cancel it. Help information is on the right side of the page.

3.3.1.2 Dynamic DNS

If user's network has a permanently assigned IP address, users can register a domain name and have that name linked with their IP address by public Domain Name Servers (DNS). However, if their Internet account uses a dynamically assigned IP address, users will not know in advance what their IP address will be, and the address can change frequently. In this case, users can use a commercial dynamic DNS service, which allows them to register their domain to their IP address, and will forward traffic directed at their domain to their frequently-changing IP address.

DDNS Service: Four-Faith router currently support DynDNS, freedns, Zoneedit, NO-IP,

3462, easyDNS, TZO, DynSIP and Custom based on the user.

DDNS Service	<input type="text" value="3322.org"/>	
User Name	<input type="text"/>	
Password	<input type="text"/>	<input type="checkbox"/> Unmask
Host Name	<input type="text"/>	
Type	<input type="text" value="Dynamic"/>	
Wildcard	<input type="checkbox"/>	
Do not use external ip check	<input checked="" type="radio"/> Yes <input type="radio"/> No	

User Name: users register in DDNS server, up to 64 characteristic

Password: password for the user name that users register in DDNS server, up to 46 characteristic

Host Name: users register in DDNS server, no limited for input characteristic for now

Type: depends on the server

Wildcard: support wildcard or not, the default is OFF. ON means *.host.3462.org is equal to host.3462.org

Do not use external ip check: enable or disable the function of 'do not use external ip check'

Force Update Interval	<input type="text" value="10"/>	(Default: 10 Days, Range: 1 - 60)
-----------------------	---------------------------------	-----------------------------------

Force Update Interval: unit is day, try forcing the update dynamic DNS to the server by setted days

Status

DDNS Status

```

Fri Nov 25 13:58:32 2011: INADYN: Started 'INADYN Advanced version 1.96-ADV' - dynamic DNS updater.
Fri Nov 25 13:58:32 2011: INADYN: IP read from cache file is '192.168.8.222'. No update required.
Fri Nov 25 13:58:32 2011: I:INADYN: IP address for alias 'testsixin.3322.org' needs update to '192.168.8.38'
Fri Nov 25 13:58:33 2011: I:INADYN: Alias 'testsixin.3322.org' to IP '192.168.8.38' updated successfully.
  
```

DDNS Status shows connection log information

3.3.1.3 Clone MAC Address

Some ISP need the users to register their MAC address. The users can clone the router MAC address to their MAC address registered in ISP if they do not want to re-register their MAC address

Enable Disable

Clone LAN MAC

Clone WAN MAC

Clone Wireless MAC

Clone MAC address can clone three parts: Clone LAN MAC, Clone WAN MAC, Clone Wireless MAC.

Noted that one MAC address is 48 characteristic, can not be set to the multicast address, the first byte must be even. And MAC address value of network bridge br0 is determined by the smaller value of wireless MAC address and LAN port MAC address.

3.3.1.4 Advanced Router

Operating Mode: Gateway and Router

Operating Mode

Operating Mode

If the router is hosting users' Internet connection, select Gateway mode. If another router exists on their network, select Router mode.

Dynamic Routing

Dynamic Routing

Interface

Dynamic Routing enables the router to automatically adjust to physical changes in the network's layout and exchange routing tables with other routers. The router determines the network packets' route based on the fewest number of hops between the source and destination.

To enable the Dynamic Routing feature for the WAN side, select WAN. To enable this feature for the LAN and wireless side, select LAN&WLAN. To enable the feature for both the WAN and LAN, select Both. To disable the Dynamic Routing feature for all data transmissions, keep the default setting, Disable.

Note : Dynamic Routing is not available in Gateway mode

Static Routing

Static Routing

Select set number:

Route Name:

Metric:

Destination LAN NET: ...

Subnet Mask: ...

Gateway: ...

Interface:

Select set number: 1-50

Route Name: defined routing name by users, up to 25 characters

Metric: 0-9999

Destination LAN NET: the Destination IP Address is the address of the network or host to which users want to assign a static route

Subnet Mask: the Subnet Mask determines which portion of an IP address is the network portion, and which portion is the host portion

Gateway: IP address of the gateway device that allows for contact between the router and the network or host.

Interface: indicate users whether the Destination IP Address is on the LAN & WLAN (internal wired and wireless networks), the WAN (Internet), or Loopback (a dummy network in which one PC acts like a network, necessary for certain software programs)

Show Routing Table

Routing Table Entry List			
Destination LAN NET	Subnet Mask	Gateway	Interface
192.168.1.1	255.255.255.255	0.0.0.0	WAN
192.168.1.0	255.255.255.0	0.0.0.0	LAN & WLAN
192.168.1.0	255.255.255.0	0.0.0.0	WAN
169.254.0.0	255.255.0.0	0.0.0.0	WAN
0.0.0.0	0.0.0.0	192.168.1.1	LAN & WLAN

3.3.1.5 VLANs

VLAN

VLAN	Port					Assigned To Bridge
	W	1	2	3	4	
0	<input type="checkbox"/>	<input checked="" type="checkbox"/>	<input checked="" type="checkbox"/>	<input checked="" type="checkbox"/>	<input checked="" type="checkbox"/>	LAN <input type="button" value="v"/>
1	<input checked="" type="checkbox"/>	<input type="checkbox"/>	<input type="checkbox"/>	<input type="checkbox"/>	<input type="checkbox"/>	None <input type="button" value="v"/>
2	<input type="checkbox"/>	<input type="checkbox"/>	<input type="checkbox"/>	<input type="checkbox"/>	<input type="checkbox"/>	None <input type="button" value="v"/>
3	<input type="checkbox"/>	<input type="checkbox"/>	<input type="checkbox"/>	<input type="checkbox"/>	<input type="checkbox"/>	None <input type="button" value="v"/>
4	<input type="checkbox"/>	<input type="checkbox"/>	<input type="checkbox"/>	<input type="checkbox"/>	<input type="checkbox"/>	None <input type="button" value="v"/>
5	<input type="checkbox"/>	<input type="checkbox"/>	<input type="checkbox"/>	<input type="checkbox"/>	<input type="checkbox"/>	None <input type="button" value="v"/>
6	<input type="checkbox"/>	<input type="checkbox"/>	<input type="checkbox"/>	<input type="checkbox"/>	<input type="checkbox"/>	None <input type="button" value="v"/>
7	<input type="checkbox"/>	<input type="checkbox"/>	<input type="checkbox"/>	<input type="checkbox"/>	<input type="checkbox"/>	None <input type="button" value="v"/>
8	<input type="checkbox"/>	<input type="checkbox"/>	<input type="checkbox"/>	<input type="checkbox"/>	<input type="checkbox"/>	None <input type="button" value="v"/>
9	<input type="checkbox"/>	<input type="checkbox"/>	<input type="checkbox"/>	<input type="checkbox"/>	<input type="checkbox"/>	None <input type="button" value="v"/>
10	<input type="checkbox"/>	<input type="checkbox"/>	<input type="checkbox"/>	<input type="checkbox"/>	<input type="checkbox"/>	None <input type="button" value="v"/>
11	<input type="checkbox"/>	<input type="checkbox"/>	<input type="checkbox"/>	<input type="checkbox"/>	<input type="checkbox"/>	None <input type="button" value="v"/>
12	<input type="checkbox"/>	<input type="checkbox"/>	<input type="checkbox"/>	<input type="checkbox"/>	<input type="checkbox"/>	None <input type="button" value="v"/>
13	<input type="checkbox"/>	<input type="checkbox"/>	<input type="checkbox"/>	<input type="checkbox"/>	<input type="checkbox"/>	None <input type="button" value="v"/>
14	<input type="checkbox"/>	<input type="checkbox"/>	<input type="checkbox"/>	<input type="checkbox"/>	<input type="checkbox"/>	None <input type="button" value="v"/>
15	<input type="checkbox"/>	<input type="checkbox"/>	<input type="checkbox"/>	<input type="checkbox"/>	<input type="checkbox"/>	None <input type="button" value="v"/>

VLANs function is to divide different VLAN ports by users' will. The system supports 16 VLAN port from VLAN0-VLAN15. However there is only 5 time ports (1 WAN port and 4 LAN port) divided by users themselves, and LAN port and WAN port disable to divide into one VLAN port meanwhile.

3.3.1.6 Networking

Bridging

Create Bridge

Bridge 0 STP Prio MTU

Assign to Bridge

Current Bridging Table

Bridge Name	STP enabled	Interfaces
br0	no	vlan0 ra0

Bridging-Create Bridge: creates a new empty network bridge for later use. STP means Spanning Tree Protocol and with PRIO users are able to set the bridge priority order. The lowest number has the highest priority.

Bridging - Assign to Bridge: allows users to assign any valid interface to a network bridge. Consider setting the Wireless Interface options to Bridged if they want to assign any Wireless Interface here. Any system specific bridge setting can be overridden here in this field.

Current Bridging Table: shows current bridging table

Create steps as below:

Click 'Add' to create a new bridge, configuration is as below:



Create bridge option: the first br0 means bridge name. STP means to on/off spanning tree protocol. Prio means priority level of STP, the smaller the number, the higher the level. MTU means maximum transfer unit, default is 1500, delete if it is not need. And then click 'Save' or 'Add'. Bridge properties is as below:



Enter relevant bridge IP address and subnet mask, click 'Add' to create a bridge.

Note: Only create a bridge can apply it.

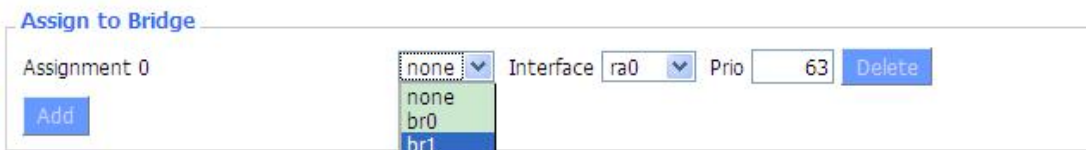

Assign to Bridge option: to assign different ports to created bridge. For example: assign port (wireless port) is ra0 in br1 bridge as below:

Prio means priority level: work if multiple ports are within the same bridge. The smaller the number, the higher the level. Click 'Add' to take it effect.

Note: corresponding interface of WAN ports interface should not be binding, this bridge function is basically used for LAN port, and should not be binding with WAN port

If bind success, bridge binding list in the list of current bridging table is as below:

Current Bridging Table

Bridge Name	STP enabled	Interfaces
br0	no	vlan0
br1	yes	ra0

To make br1 bridge has the same function with DHCP assigned address, users need to set multiple DHCP function, see the introduction of multi-channel DHCPD:

Port Setup

Network Configuration eth2	<input type="radio"/> Unbridged	<input checked="" type="radio"/> Default
Network Configuration vlan0	<input type="radio"/> Unbridged	<input checked="" type="radio"/> Default
Network Configuration ra0	<input type="radio"/> Unbridged	<input checked="" type="radio"/> Default
Network Configuration apcli0	<input type="radio"/> Unbridged	<input checked="" type="radio"/> Default
Network Configuration wds0	<input type="radio"/> Unbridged	<input checked="" type="radio"/> Default
Network Configuration wds1	<input type="radio"/> Unbridged	<input checked="" type="radio"/> Default
Network Configuration wds2	<input type="radio"/> Unbridged	<input checked="" type="radio"/> Default
Network Configuration wds3	<input type="radio"/> Unbridged	<input checked="" type="radio"/> Default
Network Configuration br0	<input type="radio"/> Unbridged	<input checked="" type="radio"/> Default

Port Setup: Set the port property, the default is not set

Network Configuration ra0	<input checked="" type="radio"/> Unbridged	<input type="radio"/> Default
MTU	<input type="text" value="1500"/>	
Multicast forwarding	<input type="radio"/> Enable	<input checked="" type="radio"/> Disable
Masquerade / NAT	<input checked="" type="radio"/> Enable	<input type="radio"/> Disable
IP Address	<input type="text" value="0"/> . <input type="text" value="0"/> . <input type="text" value="0"/> . <input type="text" value="0"/>	
Subnet Mask	<input type="text" value="0"/> . <input type="text" value="0"/> . <input type="text" value="0"/> . <input type="text" value="0"/>	

Choose not bridge to set the port's own properties, detailed properties are as below:

MTU: maximum transfer unit

Multicast forwarding: enable or disable multicast forwarding

Masquerade/NAT: enable or disable Masquerade/NAT

IP Address: set ra0's IP address, and do not conflict with other ports or bridge

Subnet Mask: set the port's subnet mask

Multiple DHCP Server

DHCP 0	<input type="text" value="ra0"/>	<input type="text" value="On"/>	Start	<input type="text" value="100"/>	Max	<input type="text" value="50"/>	Leasetime	<input type="text" value="3600"/>
<input type="button" value="Delete"/>								
<input type="button" value="Add"/>								

Multiple DHCPD: using multiple DHCP service. Click 'Add' in multiple DHCP server to appear relevant configuration. The first means the name of port or bridge (do not be configured as eth0), the second means whether to on DHCP. Start means start address, Max means maximum assigned DHCP clients, Leasetime means the client lease time, the unit is second, click 'Save' or 'Apply' to put it into effect after setting.

Note: Only configure and click 'Save' can configure the next, can not configure multiple DHCP at the same time.

3.3.2 Wireless

3.3.2.1 Basic Settings

Wireless Physical Interface w10 [2.4 GHz]

Wireless Network Enable Disable

Physical Interface ra0 - SSID [dd-junjinlee] HWAddr [00:AA:BB:CC:DD:15]

Wireless Mode	AP
Wireless Network Mode	N-Only
802.11n Transmission Mode	Mixed
Wireless Network Name (SSID)	dd-junjinlee
Wireless Channel	11 - 2.462 GHz
Channel Width	40 MHz
Extension Channel	upper
Wireless SSID Broadcast	<input checked="" type="radio"/> Enable <input type="radio"/> Disable
Network Configuration	<input type="radio"/> Unbridged <input checked="" type="radio"/> Bridged

Virtual Interfaces

Add

Save
Apply Settings
Cancel Changes

Wireless Network: “Eanble”, radio on.
 “Disable”, radio off.

Wireless Mode: AP, Client, Adhoc, Repeater, Repeater Bridge four options。

Wireless Network Mode:

Mixed: Support 802.11b, 802.11g, 802.11n wireless devices.

BG-Mixed: Support 802.11b, 802.11g wireless devices.

B-only: Only supports the 802.11b standard wireless devices.

B-only: Only supports the 802.11b standard wireless devices.

G-only: Only supports the 802.11g standard wireless devices.

NG-Mixed: Support 802.11g, 802.11n wireless devices.

N-only : Only supports the 802.11g standard wireless devices.

802.11n Transmission Mode: In the wireless network mode to "N-only" choose to transfer its transmission mode.

Greenfield: When you determine the surrounding environment, there is no other 802.11a/b/g devices use the same channel, use this mode to increase throughput. Other 802.11a/b/g devices use the same channel in the environment, the information you send may generate an error, re-issued.

Mixed: This mode is contrary to the green mode, but will reduce the throughput.

Wireless Network Name(SSID): The SSID is the network name shared among all devices in a wireless network. The SSID must be identical for all devices in the wireless network. It is case-sensitive and must not exceed 46 alphanumeric characters, which may be any keyboard character. Make sure this setting is the same for all devices in your wireless network.。

Wireless Channel: A total of 1-13 channels to choose more than one wireless device environment, please try to avoid using the same channel with other devices.。

Channel Width: 20MHZ and 40MHZ.。

Extension Channel: Channel for 40MHZ, you can choose upper or lower.

Wireless SSID Broadcast:

Enable: SSID broadcasting.

Disable: Hidden SSID.

Network Configuration:

Bridged: Bridge to the router, under normal circumstances, please select the bridge.

Unbridged: There is no bridge to the router, IP addresses need to manually configure.

Network Configuration	<input checked="" type="radio"/> Unbridged <input type="radio"/> Bridged
Multicast forwarding	<input type="radio"/> Enable <input checked="" type="radio"/> Disable
Masquerade / NAT	<input checked="" type="radio"/> Enable <input type="radio"/> Disable
IP Address	<input type="text" value="192"/> . <input type="text" value="168"/> . <input type="text" value="1"/> . <input type="text" value="1"/>
Subnet Mask	<input type="text" value="255"/> . <input type="text" value="255"/> . <input type="text" value="0"/> . <input type="text" value="0"/>

Virtual Interfaces: Click Add to add a virtual interface. Add successfully, click on the remove, you can remove the virtual interface.。

Virtual Interfaces

Virtual Interfaces ra1 SSID [dd-wrt_vap] HWAddr [00:AA:BB:CC:DD:16]

Wireless Network Name (SSID)	<input type="text" value="dd-wrt_vap"/>
Wireless SSID Broadcast	<input checked="" type="radio"/> Enable <input type="radio"/> Disable
AP Isolation	<input type="radio"/> Enable <input checked="" type="radio"/> Disable
Network Configuration	<input type="radio"/> Unbridged <input checked="" type="radio"/> Bridged

AP Isolation: This setting isolates wireless clients so access to and from other wireless clients are stopped.

Note : Save your changes, after changing the "Wireless Mode", "Wireless Network Mode", "wireless width", "broadband" option, please click on this button, and then configure the other options.

3.3.2.2 Wireless Security

Wireless security options used to configure the security of your wireless network. This route is a total of seven kinds of wireless security mode. Disabled by default, not safe mode is enabled. Such as changes in Safe Mode, click Apply to take effect immediately.

Wireless Security w10

Physical Interface ra0 SSID [dd-junjinlee] HWAddr [00:AA:BB:CC:DD:15]

Security Mode Disabled

Save
Apply Settings

Wireless Security w10

Physical Interface ra0 SSID [dd-junjinlee] HWAddr [00:AA:BB:CC:DD:15]

Security Mode WEP

Authentication Type Open Shared Key

Default Transmit Key 1 2 3 4

Encryption 64 bits 10 hex digits

Passphrase 6666666666666666 Generate

Key 1 2627F68597

Key 2 15AD1DD294

Key 3 DDC4761939

Key 4 31F1ADB558

WEP: Is a basic encryption algorithm is less secure than WPA. Use of WEP is discouraged due to security weaknesses, and one of the WPA modes should be used whenever possible. Only use WEP if you have clients that can only support WEP (usually older, 802.11b-only clients).

Authentication Type: Open or shared key.

Default Transmit Key: Select the key form Key 1 - Key 4 key.

Encryption: There are two levels of WEP encryption, 64-bit (40-bit) and 128-bit. To utilize WEP, select the desired encryption bit, and enter a passphrase or up to four WEP key in hexadecimal format. If you are using 64-bit (40-bit), then each key must consist of exactly 10 hexadecimal characters. For 128-bit, each key must consist of exactly 26 hexadecimal characters. Valid hexadecimal characters are "0"- "9" and "A"- "F"..

Passphrase : The letters and numbers used to generate a key.

Key1-Key4: Manually fill out or generated according to input the pass phrase.

Wireless Security w10

Physical Interface ra0 SSID [dd-junjinlee] HWAddr [00:AA:BB:CC:DD:15]

Security Mode ▼

WPA Algorithms ▼

WPA Shared Key Unmask

Key Renewal Interval (in seconds) (Default: 3600, Range: 1 - 99999)

WPA Personal/WPA2 Personal/WPA2 Person Mixed: , TKIP/AES/TKIP+AES , dynamic encryption keys. TKIP + AES, self-applicable TKIP or AES. WPA Person Mixed, allow WPA Personal and WPA2 Personal client mix.

WPA Shared Key: Between 8 and 63 ASCII character or hexadecimal digits.。

Key Renewal Interval (in seconds): 1-99999.。

Wireless Security w10

Physical Interface ra0 SSID [dd-junjinlee] HWAddr [00:AA:BB:CC:DD:15]

Security Mode ▼

WPA Algorithms ▼

Radius Auth Server Address

Radius Auth Server Port (Default: 1812)

Radius Auth Shared Secret Unmask

Key Renewal Interval (in seconds)

WPA Enterprise/WPA2 Enterprise/WPA2 Enterprise Mixed: WPA Enterprise uses an external RADIUS server to perform user authentication.

WPA Algorithms: AES/TKIP/TPIP+AES.

Radius Auth Sever Address: The IP address of the RADIUS server.

Radius Auth Server Port: The RADIUS Port (default is 1812)。

Radius Auth Shared Secret: The shared secret from the RADIUS server.。

Key Renewal Interva(in seconds): 1-99999.。

Wireless Security w10

Physical Interface ra0 SSID [dd-junjinlee] HWAddr [00:AA:BB:CC:DD:15]

Security Mode 802.1x ▼

XSupplicant Type Peap TTLS

User

Anonymous Identity

Password

Phase2

Public Server Certificate

Additional Network Options

802.1x: 802.1x for user to connect to a wireless access point and cable converter to provide the certification. It will limit without obtaining the user credentials to connect to the Internet, credentials - for example, a separate server authentication user name and password.

Peap: PEAP (Protected Extensible Authentication Protocol) is a version of EAP, the authentication protocol used in wireless networks and Point-to-Point connections. PEAP is designed to provide more secure authentication for 802.11 WLANs (wireless local area networks) that support 802.1X port access control. Here is PEAP-EAP-MS-CHAPv2.

1. Enter the User.
2. Enter the Password.

TTLS: TTLS uses the TLS channel to exchange "attribute-value pairs" (AVPs), much like RADIUS. (In fact, the AVP encoding format is very similar to RADIUS.) The general encoding of information allows a TTLS server to validate AVPs against any type of authentication mechanism. TTLS implementations today support all methods defined by EAP, as well as several older methods (CHAP, PAP, MS-CHAP and MS-CHAPv2). TTLS can easily be extended to work with new protocols by defining new attributes to support new protocols.

1. Enter the User.
2. Enter the Password.
3. Enter the Public Server Certificate.

3.3.3 Services

3.3.3.1 Services

DHCP Client

DHCP Client

Set Vendorclass

Request IP

Set Vendorclass: the DHCP server can automatically identify the specific identifier of the computer running certain operating systems to send, such as the DHCP server can identify the DHCP client running the operating system is Windows 2000 or Windows 98. Identification identifier DHCP option can be assigned to DHCP clients based on specific operating system.

Request IP: IP address of the request

DHCP Server

DHCPd assigns IP addresses to users local devices. While the main configuration is on the setup page users can program some nifty special functions here.

DHCP Server

Use JFFS2 for client lease DB (Not mounted)

Use NVRAM for client lease DB

Used Domain WAN

LAN Domain

Additional DHCPd Options

Static Leases			
MAC Address	Host Name	IP Address	Client Lease Time
<input type="text"/>	<input type="text"/>	<input type="text"/>	<input type="text"/> minutes

Use NVRAM for client lease DB: users can store data to the system NVRAM area is enabled

Used domain: users can select here which domain the DHCP clients should get as their local domain. This can be the WAN domain set on the Setup screen or the LAN domain which can be set here.

LAN Domain: users can define here their local LAN domain which is used as local domain for DNSmasq and DHCP service if chose above.

Static Leases: if users want to assign certain hosts a specific address then they can define them here. This is also the way to add hosts with a fixed address to the router's local DNS service (DNSmasq).

Additional DHCPd Options: some extra options users can set by entering them

DNSMasq

DNSmasq is a local DNS server. It will resolve all host names known to the router from dhcp (dynamic and static) as well as forwarding and caching DNS entries from remote DNS servers.

Local DNS enables DHCP clients on the LAN to resolve static and dynamic DHCP hostnames.

DNSMasq

DNSMasq	<input checked="" type="radio"/> Enable	<input type="radio"/> Disable
Local DNS	<input type="radio"/> Enable	<input checked="" type="radio"/> Disable
No DNS Rebind	<input checked="" type="radio"/> Enable	<input type="radio"/> Disable
Additional DNSMasq Options	<input type="text"/>	

Local DNS: enables DHCP clients on the LAN to resolve static and dynamic DHCP hostnames
No DNS Rebind: when enabled, it can prevent an external attacker to access the router's internal Web interface. It is a security measure
Additional DNSMasq Options: some extra options users can set by entering them in Additional DNS Options.

For example:

static allocation: dhcp-host=AB:CD:EF:11:22:33,192.168.0.10,myhost,myhost.domain,12h

max lease number: dhcp-lease-max=2

DHCP server IP range: dhcp-range=192.168.0.110,192.168.0.111,12h

SNMP

SNMP

SNMP	<input checked="" type="radio"/> Enable	<input type="radio"/> Disable
Location	<input type="text" value="Unknown"/>	
Contact	<input type="text" value="root"/>	
Name	<input type="text" value="four-faith"/>	
RO Community	<input type="text" value="public"/>	
RW Community	<input type="text" value="private"/>	

Location: equipment location

Contact: contact this equipment management

Name: device name

RO Community: SNMP RO community name, the default is public, Only to read.

RW Community: SNMP RW community name, the default is private, Read-write permissions

SSHD

Enabling SSHd allows users to access the Linux OS of their router with an SSH client

Secure Shell

SShd	<input checked="" type="radio"/> Enable	<input type="radio"/> Disable
SSH TCP Forwarding	<input type="radio"/> Enable	<input checked="" type="radio"/> Disable
Password Login	<input checked="" type="radio"/> Enable	<input type="radio"/> Disable
Port	<input type="text" value="22"/>	(Default: 22)
Authorized Keys	<input type="text"/>	

SSH TCP Forwarding: enable or disable to support the TCP forwarding

Password Login: allows login with the router password (username is root)

Port: port number for SSHd (default is 22)

Authorized Keys: here users paste their public keys to enable key-based login (more secure than a simple password)

System log

Enable Syslogd to capture system messages. By default they will be collected in the local file /var/log/messages. To send them to another system, enter the IP address of a remote syslog server.

System Log

Syslogd	<input checked="" type="radio"/> Enable	<input type="radio"/> Disable
Syslog Out Mode	<input checked="" type="radio"/> Net	<input type="radio"/> Console
Remote Server	<input type="text"/>	

Syslog Out Mode: two log mode

Net: the log information output to a syslog server

Console: the log information output to console port

Remote Server: if choose net mode, users should input a syslog server's IP Address and run a syslog server program on it.

Telnet

Telnet

Telnet	<input checked="" type="radio"/> Enable	<input type="radio"/> Disable
--------	---	-------------------------------

Telnet: enable a telnet server to connect to the router with telnet. The username is root and the password is the router's password.

Note: If users use the router in an untrusted environment (for example as a public hotspot), it is strongly recommended to use SSHd and deactivate telnet.

WAN Traffic Counter

WAN Traffic Counter

ttraff Daemon	<input checked="" type="radio"/> Enable	<input type="radio"/> Disable
---------------	---	-------------------------------

Ttraff Daemon: enable or disable wan traffic counter function

3.3.4 VPN

3.3.4.1 PPTP

PPTP Server

PPTP Server

PPTP Server Enable Disable

Broadcast support Enable Disable

Force MPPE Encryption Enable Disable

DNS1

DNS2

WINS1

WINS2

Server IP

Client IP(s)

CHAP-Secrets

Broadcast support: enable or disable broadcast support of PPTP server

Force MPPE Encryption: enable or disable force MPPE encryption of PPTP data

DNS1/DNS2/WINS1/WINS2: set DNS1/DNS2/WINS1/WINS2

Server IP: input IP address of the router as PPTP server, differ from LAN address

Client IP(s): IP address assigns to the client, the format is xxx.xxx.xxx.xxx-xxx

CHAP Secrets: user name and password of the client using PPTP service

Note: client IP must be different with IP assigned by router DHCP.

The format of CHAP Secrets is user * password *.

PPTP Client

PPTP Client

PPTP Client Options Enable Disable

Server IP or DNS Name

Remote Subnet

Remote Subnet Mask

MPPE Encryption

MTU (Default: 1450)

MRU (Default: 1450)

NAT Enable Disable

Fixed IP Enable Disable

Fixed IP Address

User Name

Password Unmask

Server IP or DNS Name: PPTP server’s IP Address or DNS Name

Remote Subnet: the network of the remote PPTP server

Remote Subnet Mask: subnet mask of remote PPTP server

MPPE Encryption: enable or disable Microsoft Point-to-Point Encryption。

MTU: maximum Transmission Unit

MRU: maximum Receive Unit

NAT: network Address Translation

Fixed IP : Enable or Disable Fixed IP

Fixed IP Address : Fixed IP Address

User Name: user name to login PPTP Server.

Password: password to log into PPTP Server.

3.3.4.2 L2TP

L2TP Server

L2TP Server

L2TP Server Options Enable Disable

Force MPPE Encryption Enable Disable

Server IP

Client IP(s)

CHAP-Secrets

Force MPPE Encryption: enable or disable force MPPE encryption of L2TP data

Server IP: input IP address of the router as PPTP server, differ from LAN address

Client IP(s): IP address assigns to the client, the format is xxx.xxx.xxx.xxx-xxx.xxx.xxx.xxx

CHAP Secrets: user name and password of the client using L2TP service

Note: client IP must be different with IP assigned by router DHCP.

The format of CHAP Secrets is user * password *.

L2TP Client

L2TP Client

L2TP Client Options Enable Disable

User Name

Password Unmask

Gateway (L2TP Server)

Remote Subnet ...

Remote Subnet Mask ...

MPPE Encryption

MTU (Default: 1450)

MRU (Default: 1450)

NAT Enable Disable

Fixed IP Enable Disable

Fixed IP Address ...

Require CHAP Yes No

Refuse PAP Yes No

Require Authentication Yes No

Gateway(L2TP Server): L2TP server's IP Address or DNS Name

Remote Subnet: the network of remote PPTP server

Remote Subnet Mask: subnet mask of remote PPTP server

MPPE Encryption: enable or disable Microsoft Point-to-Point Encryption

MTU: maximum transmission unit

MRU: maximum receive unit

NAT: network address translation

Fixed IP : Enable or Disable Fixed IP

Fixed IP Address : Fixed IP Address

User Name: user name to login L2TP Server

Password: password to login L2TP Server

Require CHAP: enable or disable support chap authentication protocol

Refuse PAP: enable or disable refuse to support the pap authentication

Require Authentication: enable or disable support authentication protocol

3.3.4.3 OPENVPN

OPENVPN Server

Start Type WAN Up System

Start Type: WAN UP----start after on-line, System----start when boot up

Config via GUI Config File

Server mode Router (TUN) Bridge (TAP)

Config via: GUI----Page configuration, Config File----config File configuration

Server mode: Router (TUN)-route mode, Bridge (TAP)----bridge mode

Router (TUN):

Network
 Netmask

Network: network address allowed by OPENVPN server

Netmask: netmask allowed by OPENVPN server

Bridge (TAP):

DHCP-Proxy mode Enable Disable
 Pool start IP
 Pool end IP
 Gateway
 Netmask

DHCP-Proxy mode: enable or disable DHCP-Proxy mode

Pool start IP: pool start IP of the client allowed by OPENVPN server

Pool end IP: pool end IP of the client allowed by OPENVPN server

Gateway: the gateway of the client allowed by OPENVPN server

Netmask: netmask of the client allowed by OPENVPN server

Port (Default: 1194)
 Tunnel Protocol
 Encryption Cipher
 Hash Algorithm

Port: listen port of OPENVPN server

Tunnel Protocol: UCP or TCP of OPENVPN tunnel protocol

Encryption Cipher: Blowfish CBC, AES-128 CBC, AES-192 CBC, AES-256 CBC, AES-512 CBC

Hash Algorithm: Hash algorithm provides a method of quick access to data, including SHA1, SHA256, SHA512, MD5

Advanced Options

Advanced Options	<input checked="" type="radio"/> Enable	<input type="radio"/> Disable
Use LZO Compression	<input type="radio"/> Enable	<input checked="" type="radio"/> Disable
Redirect default Gateway	<input type="radio"/> Enable	<input checked="" type="radio"/> Disable
Allow Client to Client	<input checked="" type="radio"/> Enable	<input type="radio"/> Disable
Allow duplicate cn	<input type="radio"/> Enable	<input checked="" type="radio"/> Disable
TUN MTU Setting	<input type="text" value="1500"/>	(Default: 1500)
MSS-Fix/Fragment across the tunnel	<input type="text"/>	(Default: Disable)
TLS Cipher	<input type="text" value="Disable"/>	
Client connect script	<input type="text"/>	

Use LZO Compression: enable or disable use LZO compression for data transfer

Redirect default Gateway: enable or disable redirect default gateway

Allow Client to Client: enable or disable allow client to client

Allow duplicate cn: enable or disable allow duplicate cn

TUN MTU Setting: set the value of TUN MTU

TCP MSS: MSS of TCP data

TLS Cipher: TLS (Transport Layer Security) encryption standard supports AES-128 SHA and AES-256 SHA

Client connect script: define some client script by user self

CA Cert	<input type="text"/>
---------	----------------------

CA Cert: CA certificate

Public Server Cert	<input type="text"/>
--------------------	----------------------

Public Server Cert: server certificate

Private Server Key	<input type="text"/>
--------------------	----------------------

DH PEM	<input type="text"/>
--------	----------------------

Private Server Key: the key seted by the server

DH PEM: PEM of the server

Additional Config

CCD-Dir DEFAULT file

TLS Auth Key

Certificate Revoke List

Additional Config: additional configurations of the server

CCD-Dir DEFAULT file: other file approaches

TLS Auth Key: authority key of Transport Layer Security

Certificate Revoke List: configure some revoke certificates

OPENVPN Client

Server IP/Name

Port

(Default: 1194)

Tunnel Device

Tunnel Protocol

Encryption Cipher

Hash Algorithm

nsCertType verification

Server IP/Name: IP address or domain name of OPENVPN server

Port: listen port of OPENVPN client

Tunnel Device: TUN----Router mode, TAP----Bridge mode

Tunnel Protocol: UDP and TCP protocol

Encryption Cipher: Blowfish CBC, AES-128 CBC, AES-192 CBC, AES-256 CBC, AES-512 CBC

Hash Algorithm: Hash algorithm provides a method of quick access to data, including SHA1, SHA256, SHA512, MD5

nsCertType verification: support ns certificate type

Advanced Options	<input checked="" type="radio"/> Enable	<input type="radio"/> Disable
Use LZO Compression	<input type="radio"/> Enable	<input checked="" type="radio"/> Disable
NAT	<input type="radio"/> Enable	<input checked="" type="radio"/> Disable
Bridge TAP to br0	<input type="radio"/> Enable	<input checked="" type="radio"/> Disable
Local IP Address	<input type="text"/>	
TUN MTU Setting	<input type="text" value="1500"/>	(Default: 1500)
MSS-Fix/Fragment across the tunnel	<input type="text"/>	(Default: Disable)
TLS Cipher	<input type="text" value="Disable"/>	
TLS Auth Key	<input type="text"/>	
Additional Config	<input type="text"/>	
Policy based Routing	<input type="text"/>	

Use LZO Compression: enable or disable use LZO compression for data transfer

NAT: enable or disable NAT through function

Bridge TAP to br0: enable or disable bridge TAP to br0

Local IP Address: set IP address of local OPENVPN client

TUN MTU Setting: set MTU value of the tunnel

TCP MSS: mss of TCP data

TLS Cipher: TLS (Transport Layer Security) encryption standard supports AES-128 SHA and AES-256 SHA

TLS Auth Key: authority key of Transport Layer Security

Additional Config: additional configurations of OPENVPN server

Policy based Routing: input some defined routing policy

CA Cert	<input type="text"/>
Public Client Cert	<input type="text"/>
Private Client Key	<input type="text"/>

CA Cert: CA certificate

Public Client Cert: client certificate

Private Client Key: client key

3.3.4.4 IPSEC

Connect Status and Control

Show IPSEC connection and status of current router on IPSEC page.

Connection status and control

Name	Type	Common Name	status	Action
Add				

Name: the name of IPSEC connection

Type: The type and function of current IPSEC connection

Common name: local subnet, local address, opposite end address and opposite end subnet of current connection

Status: connection status: closed, negotiating, establish

Closed: this connection does not launch a connection request to opposite end

Negotiating: this connection launch a request to opposite end, is under negotiating, the connection has not been established yet

Establish: the connection has been established, enabled to use this tunnel

Action: the action of this connection, current is to delete, edit, reconnect and enable

Delete: to delete the connection, also will delete IPSEC if IPSEC has set up

Edit: to edit the configure information of this connection, reload this connection to make the configuration effect after edit

Reconnect: this action will remove current tunnel, and re-launch tunnel establish request

Enable: when the connection is enable, it will launch tunnel establish request when the system reboot or reconnect, otherwise the connection will not do it

Add: to add a new IPSEC connection

Add IPSEC connection or edit IPSEC connection

Type: to choose IPSEC mode and relevant functions in this part, supports tunnel mode client, tunnel mode server and transfer mode currently

Type

Type:

IPSEC role: Client Server

Connection: this part contains basic address information of the tunnel

Connection

Name	<input type="text"/>	Enabled	<input checked="" type="checkbox"/>
Local WAN Interface	<input type="text" value="vlan1"/>	Remote Host address	<input type="text"/>
Local Subnet	<input type="text"/>	Remote subnet	<input type="text"/>
Local Id	<input type="text"/>	Remote ID	<input type="text"/>

Name: to indicate this connection name, must be unique

Enabled: If enable, the connection will send tunnel connection request when it is reboot or re-connection, otherwise it is no need if disable

Local WAN Interface: local addresss of the tunnel

Remote Host Address: IP/domain name of end opposite; this option can not fill in if using tunnel mode server

Local Subnet: IPSec local protects subnet and subnet mask, i.e. 192.168.1.0/24; this option can not fill in if using transfer mode

Remote Subnet: IPSec opposite end protects subnet and subnet mask, i.e.192.168.7.0/24; this option can not fill in if using transfer mode

Local ID: tunnel local end identification, IP and domain name are available

Remote ID: tunnel opposite end identification, IP and domain name are available

Detection: this part contains configure information of connection detection

Detection

Enable DPD Detection

Time Interval (S) Timeout (S) Action

Enable Connection Detection

Enable DPD Detection: enable or disable this function, tick means enable

Time Interval: set time interval of connect detection (DPD)

Timeout: set the timeout of connect detection

Action: set the action of connect detection

Advanced Settings: this part contains relevant setting of IKE, ESP, negotiation mode, etc.

Advanced Settings

Enable advanced settings

IKE Encryption IKE Integrity IKE Grouptype

IKE Lifetime hours

ESP Encryption ESP Integrity

ESP Keylife hours

IKE+ESP: Use only proposed settings.

IKE aggressive mode allowed. Avoid if possible (preshared key is transmitted in clear text)!

Perfect Forward Secrecy (PFS)

Negotiate payload compression

Enable Advanced Settings: enable to configure 1st and 2nd phase information, otherwise it will automic negotiation according to opposite end

IKE Encryption: IKE phased encryption mode

IKE Integrity: IKE phased integrity solution

IKE Grouptype: DH exchange algorithm

IKE Lifetime: set IKE lifetime, current unit is hour, the default is 0

ESP Encryption: ESP encryption type

ESP Integrity: ESP integrity solution

ESP Keylife: set ESP keylife, current unit is hour, the default is 0

IKE aggressive mode allowed: negotiation mode adopt aggressive mode if tick; it is main mode if non-tick

Negotiate payload compression: Tick to enable PFS, non-tick to diable PFS

Authentication: choose use share encryption option or certificate authentication option. Current is only to choose use share encryption option.

Authentication

Use a Pre-Shared Key:

Generate and use the X.509 certificate

3.3.4.5 GRE

GRE (Generic Routing Encapsulation, Generic Routing Encapsulation) protocol is a network layer protocol (such as IP and IPX) data packets are encapsulated, so these encapsulated data packets to another network layer protocol (IP)transmission. GRE Tunnel (tunnel) technology, Layer Two Tunneling Protocol VPN (Virtual Private Network).

GRE Tunnel

GRE Tunnel Enable Disable

GRE Tunnel: enable or disable GRE function

Number	1 (fff) <input type="button" value="Delete"/>
Status	Enable <input type="button" value="v"/>
Name	fff <input type="text"/>
Through	PPP <input type="button" value="v"/>
Peer Wan IP Addr	120.42.46.98 <input type="text"/>
Peer Subnet	192.168.5.0/24 (eg:192.168.1.0/24) <input type="text"/>
Peer Tunnel IP	200.200.200.1 <input type="text"/>
Local Tunnel IP	200.200.200.5 <input type="text"/>
Local Netmask	255.255.255.0 <input type="text"/>

Number : Switch on/off GRE tunnel app

Status : Switch on/off someone GRE tunnel app

Name : GRE tunnel name

Through : The GRE packet transmit interface

Peer Wan IP Addr : The remote WAN address

Peer Subnet : The remote gateway local subnet, eg: 192.168.1.0/24

Peer Tunnel IP : The remote tunnel ip address

Local Tunnel IP : The local tunnel ip address

Local Netmask : Netmask of local network

Keepalive Enable Disable

Retry times

Interval

Fail Action 

Keepalive : Enable or disable GRE Keepalive function

Retry times : GRE keepalive detect fail retries

Interval : The time interval of GRE keepalive packet sent

Fail Action : The action would be exec after keeping alive failed

Click on “**View GRE tunnels**” keys can view the information of GRE

GRE Tunnels list												
Number	Name	Enable	Through	Peer Wan IP Addr	Peer Subnet	Peer Tunnel IP	Local Tunnel IP	Local Netmask	Keepalive	Retry times	Interval	Fail Action
1	fff	Yes	PPP	120.42.46.98	192.168.5.0/24	200.200.200.1	200.200.200.5	255.255.255.0	No	0	0	Hold

3.3.5 Security

3.3.5.1 Firewall

You can enable or disable the firewall, filter specific Internet data types, and prevent anonymous Internet requests, ultimately enhance network security.

Firewall Protection

Firewall Protection

SPI Firewall Enable Disable

Firewall enhance network security and use SPI to check the packets into the network. To use firewall protection, choose to enable otherwise disabled. Only enable the SPI firewall, you can use other firewall functions: filtering proxy, block WAN requests, etc.

Additional Filters

Additional Filters

- Filter Proxy
- Filter Cookies
- Filter Java Applets
- Filter ActiveX

Filter Proxy: Wan proxy server may reduce the security of the gateway, Filtering Proxy will refuse any access to any wan proxy server. Click the check box to enable the function otherwise disabled.

Filter Cookies: Cookies are the website of data the data stored on your computer. When you interact with the site, the cookies will be used. Click the check box to enable the function

otherwise disabled.

Filter Java Applets: If refuse to Java, you may not be able to open web pages using the Java programming.. Click the check box to enable the function otherwise disabled.

Filter ActiveX: If refuse to ActiveX, you may not be able to open web pages using the ActiveX programming. Click the check box to enable the function otherwise disabled.

Prevent WAN Request

Block WAN Requests

- Block Anonymous WAN Requests (ping)
- Filter IDENT (Port 113)
- Block WAN SNMP access

Block Anonymous WAN Requests (ping): By selecting “Block Anonymous WAN Requests (ping)” box to enable this feature, you can prevent your network from the Ping or detection of other Internet users. so that make More difficult to break into your network. The default state of this feature is enabled ,choose to disable allow anonymous Internet requests.

Filter IDENT (Port 113): Enable this feature can prevent port 113 from being scanned from outside. Click the check box to enable the function otherwise disabled.

Block WAN SNMP access: This feature prevents the SNMP connection requests from the WAN. After Complete the changes, click the **Save Settings** button to save your changes. Click the **Cancel Changes** button to cancel unsaved changes.

Impede WAN DoS/Bruteforce

Impede WAN DoS/Bruteforce

- Limit SSH Access
- Limit Telnet Access
- Limit PPTP Server Access
- Limit L2TP Server Access

Limit ssh Access: This feature limits the access request from the WAN by ssh, and per minute up to accept two connection requests on the same IP. Any new access request will be automatically dropped.

Limit Telnet Access: This feature limits the access request from the WAN by Telnet, and per minute up to accept two connection requests on the same IP. Any new access request will be automatically dropped.

Limit PPTP Server Access: When build a PPTP Server in the router,this feature limits the access request from the WAN by ssh, and per minute up to accept two connection requests on the same IP . Any new access request will be automatically dropped.

Limit L2TP Server Access: When build a L2TP Server in the router, this feature limits the access request from the WAN by ssh, and per minute up to accept two connection requests on the same IP. Any new access request will be automatically dropped.

Log Management

The router can keep logs of all incoming or outgoing traffic for your Internet connection.

Log

Log Enable Disable

Log: To keep activity logs, select Enable. To stop logging, select Disable. When select enable, the following page will appear.

Log

Log Enable Disable

Log Level

Options

Dropped

Rejected

Accepted

Log Level: Set this to the required log level. Set Log Level higher to log more actions.

Options: When select Enable, the corresponding connection will be recorded in the journal, the disabled are not recorded.

Incoming Log: To see a temporary log of the Router's most recent incoming traffic, click the Incoming Log button.

Incoming Log Table

Source IP	Protocol	Destination Port Number	Rule
<input type="button" value="Refresh"/> <input type="button" value="Close"/>			

Outgoing Log: To see a temporary log of the Router's most recent outgoing traffic, click the Outgoing Log button.

Outgoing Log Table

LAN IP	Destination URL/IP	Protocol	Service/Port Number	Rule
192.168.1.164	223.203.188.56	TCP	www	Accepted
192.168.1.164	183.60.16.200	UDP	8000	Accepted
192.168.1.164	183.60.48.60	UDP	8000	Accepted
192.168.1.164	112.95.240.183	UDP	8000	Accepted
192.168.1.164	183.60.49.245	UDP	8000	Accepted
192.168.1.164	119.147.32.204	UDP	8000	Accepted
192.168.1.164	112.90.86.244	UDP	8000	Accepted
192.168.1.164	119.147.45.157	UDP	8000	Accepted
192.168.1.164	183.60.49.15	UDP	8000	Accepted
192.168.1.164	183.60.16.70	UDP	8000	Accepted
192.168.1.164	183.60.16.200	UDP	8000	Accepted
192.168.1.164	183.60.48.60	UDP	8000	Accepted

Click the **Save Settings** button to save your changes. Click the **Cancel Changes** button to cancel unsaved changes.

3.3.6 Access Restrictions

3.3.6.1 WAN Access

Use access restrictions, you can block or allow specific types of Internet applications. You can set specific PC-based Internet access policies. This feature allows you to customize up to ten different Internet Access Policies for particular PCs, which are identified by their IP or MAC addresses.

Access Policy

Policy: 1 () Delete Summary

Status: Enable Disable

Policy Name:

PCs: Edit List of clients

Deny Internet access during selected days and hours.

Filter

Two options in the default policy rules: "Filter" and "reject". If select "Deny", you will deny specific computers to access any Internet service at a particular time period. If you choose to "filter", It will block specific computers to access the specific sites at a specific time period. You can set up 10 Internet access policies filtering specific PCs access Internet services at a particular time period.

Access Policy: You may define up to 10 access policies. Click Delete to delete a policy or Summary to see a summary of the policy.

Status: Enable or disable a policy.

Policy Name: You may assign a name to your policy.

PCs: The part is used to edit client list, the strategy is only effective for the PC in the list.

Days

Everyday	Sun	Mon	Tue	Wed	Thu	Fri	Sat
<input checked="" type="checkbox"/>	<input type="checkbox"/>	<input type="checkbox"/>	<input type="checkbox"/>	<input type="checkbox"/>	<input type="checkbox"/>	<input type="checkbox"/>	<input type="checkbox"/>

Times

24 Hours

From 00:00 To 00:00

Days: Choose the day of the week you would like your policy to be applied.

Times: Enter the time of the day you would like your policy to be applied.

Website Blocking by URL Address

<input type="text"/>	<input type="text"/>	<input type="text"/>
<input type="text"/>	<input type="text"/>	<input type="text"/>
<input type="text"/>	<input type="text"/>	<input type="text"/>

Website Blocking by Keyword

<input type="text"/>	<input type="text"/>	<input type="text"/>	<input type="text"/>
<input type="text"/>	<input type="text"/>	<input type="text"/>	<input type="text"/>

Website Blocking by URL Address: You can block access to certain websites by entering their URL.

Website Blocking by Keyword: You can block access to certain website by the keywords contained in their webpage

List of clients

Enter MAC Address of the clients in this format: xx:xx:xx:xx:xx:xx

MAC 01	<input type="text" value="00:AA:BB:CC:DD:EE"/>
MAC 02	<input type="text" value="00:00:00:00:00:00"/>
MAC 03	<input type="text" value="00:00:00:00:00:00"/>
MAC 04	<input type="text" value="00:00:00:00:00:00"/>
MAC 05	<input type="text" value="00:00:00:00:00:00"/>
MAC 06	<input type="text" value="00:00:00:00:00:00"/>
MAC 07	<input type="text" value="00:00:00:00:00:00"/>
MAC 08	<input type="text" value="00:00:00:00:00:00"/>

Enter the IP Address of the clients

IP 01	192.168.1.	<input type="text" value="15"/>
IP 02	192.168.1.	<input type="text" value="0"/>
IP 03	192.168.1.	<input type="text" value="0"/>
IP 04	192.168.1.	<input type="text" value="0"/>
IP 05	192.168.1.	<input type="text" value="0"/>
IP 06	192.168.1.	<input type="text" value="0"/>

Enter the IP Range of the clients

IP Range 01	<input type="text" value="192"/>	.	<input type="text" value="168"/>	.	<input type="text" value="1"/>	.	<input type="text" value="19"/>	~	<input type="text" value="192"/>	.	<input type="text" value="168"/>	.	<input type="text" value="1"/>	.	<input type="text" value="30"/>
IP Range 02	<input type="text" value="0"/>	.	<input type="text" value="0"/>	.	<input type="text" value="0"/>	.	<input type="text" value="0"/>	~	<input type="text" value="0"/>	.	<input type="text" value="0"/>	.	<input type="text" value="0"/>	.	<input type="text" value="0"/>

set up Internet access policy

1. Select the policy number (1-10) in the drop-down menu.
2. For this policy is enabled, click the radio button next to "Enable"

3. Enter a name in the Policy Name field.
4. Click the Edit List of PCs button.
5. On the List of PCs screen, specify PCs by IP address or MAC address. Enter the appropriate IP addresses into the IP fields. If you have a range of IP addresses to filter, complete the appropriate IP Range fields. Enter the appropriate MAC addresses into the MAC fields.
6. Click the Apply button to save your changes. Click the Cancel button to cancel your unsaved changes. Click the Close button to return to the Filters screen.
7. If you want to block the listed PCs from Internet access during the designated days and time, then keep the default setting, Deny. If you want the listed PCs to have Internet filtered during the designated days and time, then click the radio button next to Filter.
8. Set the days when access will be filtered. Select Everyday or the appropriate days of the week.
9. Set the time when access will be filtered. Select 24 Hours, or check the box next to From and use the drop-down boxes to designate a specific time period.
10. Click the Add to Policy button to save your changes and active it.
11. To create or edit additional policies, repeat steps 1-9.
12. To delete an Internet Access Policy, select the policy number, and click the Delete button.

Note:

- 1) The default factory value of policy rules is "filtered". If the user chooses the default policy rules for "refuse", and editing strategies to save or directly to save the settings. If the strategy edited is the first, it will be automatically saved into the second, if not the first, keep the original number.
- 2) Turn off the power of the router or reboot the router can cause a temporary failure。 After the failure of the router, if can not automatically synchronized NTP time server, you need to recalibrate to ensure the correct implementation of the relevant period control function.

3.3.6.2 Packet Filter

To block some packets getting Internet access or block some Internet packets getting local network access, you can configure filter items to block these packets.

Packet Filter

Packet filter function is realized based on IP address or port of packets.

Enable Packet Filter Enable Disable

Policy

Enable Packet Filter: Enable or disable “packet filter” function

Policy: The filter rule’s policy, you can choose the following options

Discard The Following--Discard packets conform to the following rules, Accept all other packets

Only Accept The Following-- Accept only the data packets conform to the following rules, Discard all other packets

Add Filter Rule

Direction: OUTPUT

Protocol: TCP/UDP

Source Ports: 1 - 65535

Destination Ports: 1 - 65535

Source IP: 0.0.0.0/0

Destination IP: 0.0.0.0/0

Add

Direction

- input:** packet from WAN to LAN
- output:** packet from LAN to WAN

- Protocol:** packet protocol type
- Source Ports:** packet's source port
- Destination Ports:** packet's destination port
- Source IP:** packet's source IP address
- Destination IP:** packet's destination IP address

Note: "Source Port" ,"Destination Port" ,"Source IP" ,"Destination IP" could not be all empty ,you have to input at least one of these four parameters.

3.3.7 NAT

3.3.7.1 Port Forwarding

Port Forwarding allows you to set up public services on your network, such as web servers, ftp servers, e-mail servers, or other specialized Internet applications. Specialized Internet applications are any applications that use Internet access to perform functions such as videoconferencing or online gaming. When users send this type of request to your network via the Internet, the router will forward those requests to the appropriate PC. If you want to forward a whole range of ports, see Port Range Forwarding.

Forwards

Application	Protocol	Source Net	Port from	IP Address	Port to	Enable
web	TCP	192.168.8.11	8000	192.168.1.12	80	<input checked="" type="checkbox"/>
ftp	Both	192.168.8.12	24	192.168.1.12	21	<input checked="" type="checkbox"/>

Add Remove

- Application:** Enter the name of the application in the field provided.
- Protocol:** Chose the right protocol TCP,UDP or Both. Set this to what the application requires.

Source Net: Forward only if sender matches this ip/net (example 192.168.1.0/24).

Port from: Enter the number of the external port (the port number seen by users on the Internet).

IP Address: Enter the IP Address of the PC running the application.

Port to: Enter the number of the internal port (the port number used by the application).

Enable: Click the Enable checkbox to enable port forwarding for the application.

Check all values and click **Save Settings** to save your settings. Click the **Cancel changes** button to cancel your unsaved changes.

3.3.7.2 Port Range Forward

Port Range Forwarding allows you to set up public services on your network, such as web servers, ftp servers, e-mail servers, or other specialized Internet applications. Specialized Internet applications are any applications that use Internet access to perform functions such as videoconferencing or online gaming. When users send this type of request to your network via the Internet, the router will forward those requests to the appropriate PC. If you only want to forward a single port, see [Port Forwarding](#).

Port Range Forward

Forwards

Application	Start	End	Protocol	IP Address	Enable
web-tftp	800	8100	Both ▾	192.168.1.16	<input checked="" type="checkbox"/>
game	9000	10000	Both ▾	192.168.1.16	<input checked="" type="checkbox"/>

Application: Enter the name of the application in the field provided.

Start: Enter the number of the first port of the range you want to be seen by users on the Internet and forwarded to your PC.

End: Enter the number of the last port of the range you want to be seen by users on the Internet and forwarded to your PC.

Protocol: Choose the right protocol TCP,UDP or Both. Set this to what the application requires.

IP Address: Enter the IP Address of the PC running the application.

Enable: Click the Enable checkbox to enable port forwarding for the application.

Check all values and click **Save Settings** to save your settings. Click the **Cancel changes** button to cancel your unsaved changes.

3.3.7.3 DMZ

The DMZ (DeMilitarized Zone) hosting feature allows one local user to be exposed to the Internet for use of a special-purpose service such as Internet gaming or videoconferencing. DMZ hosting forwards all the ports at the same time to one PC. The Port Forwarding feature is more secure because it only opens the ports you want to have opened, while DMZ hosting opens all the ports of one computer, exposing the computer so the Internet can see it.

Demilitarized Zone (DMZ)

DMZ

Use DMZ Enable Disable

DMZ Host IP Address 192.168.8.

Any PC whose port is being forwarded must should have a new static IP address assigned to it because its IP address may change when using the DHCP function.

DMZ Host IP Address: To expose one PC to the Internet, select Enable and enter the computer's IP address in the DMZ Host IP Address field. To disable the DMZ, keep the default setting : Disable

Check all values and click **Save Settings** to save your settings. Click the **Cancel changes** button to cancel your unsaved changes.

3.3.8 QoS Setting

3.3.8.1 Basic

Bandwidth management prioritizes the traffic on your router. Interactive traffic (telephony, browsing, telnet, etc.) gets priority and bulk traffic (file transfer, P2P) gets low priority. The main goal is to allow both types to live side-by side without unimportant traffic disturbing more critical things. All of this is more or less automatic.

QoS allows control of the bandwidth allocation to different services, netmasks, MAC addresses and the four LAN ports.

Main WAN QoS Settings

Start QoS Enable Disable

Port

Packet Scheduler

Uplink (kbps)

Downlink (kbps)

Bkup WAN QoS Settings

Start QoS Enable Disable

Port

Packet Scheduler

Uplink (kbps)

Downlink (kbps)

Uplink (kbps) : In order to use bandwidth management (QoS) you must enter bandwidth values for your uplink. These are generally 80% to 90% of your maximum bandwidth.

Downlink (kbps) :In order to use bandwidth management (QoS) you must enter bandwidth values for your downlink. These are generally 80% to 90% of your maximum bandwidth.

3.3.8.2 Classify

Netmask Priority

Netmask Priority

Delete	IP/Mask	Priority
<input type="checkbox"/>	192.168.1.1/24	Exempt
<input type="checkbox"/>	192.168.2.3/24	Standard
<input type="checkbox"/>	192.168.3.4/32	Express
<input type="checkbox"/>	192.168.4.5/32	Bulk

.
 .
 .
 /

You may specify priority for all traffic from a given IP address or IP Range.

3.3.9 Applications

3.3.9.1 Serial Applications

There is a console port on Four-Faith router. Normally, this port is used to debug the router. This port can also be used as a serial port. The router has embedded a serial to TCP program. The data sent to the serial port is encapsulated by TCP/IP protocol stack and then is sent to the destination server. This function can work as a Four-Faith DTU (Data Terminal Unit). Please refer www.four-faith.com for more information about this product.

Serial Applications

Serial Applications Enable Disable

Baudrate

Databit

Stopbit

Parity

Flow Control

Protocol

Server Address

Server Port

Device Number

Device Id

Heartbeat Interval

- Baudrate:** Baud rate indicates the number of bytes per second transported by device, commonly used baud rate is 115200, 57600, 38400, 19200.
- Databit:** the data bits can be 4, 5, 6, 7, 8, constitute a character. The ASCII code is usually used. Starting from the most significant bit is transmitted,.
- Stopbit:** it marks the end of a character data. It is a high level of 1, 1.5, 2.
- Parity:** use a set of data to check the data error .
- Flow control:** including the hardware part and software part in two ways.
- Enable Serial TCP Function:** Enable the serial to TCP function
- Protocol Type:** The protocol type to transmit data.
- UDP(DTU) – Data transmit with UDP protocol , work as a Four-Faith DTU which has application protocol and hear beat mechanism.
 - Pure UDP – Data transmit with standard UDP protocol.
 - TCP(DTU) -- Data transmit with TCP protocol , work as a Four-Faith DTU which has application protocol and hear beat mechanism.
 - Pure TCP -- Data transmit with standard TCP protocol, router is the client.
 - TCP Server -- Data transmit with standard TCP protocol, router is the server.
 - TCST -- Data transmit with TCP protocol, Using a custom data
- Server Address:** The data service center’s IP Address or domain name.
- Server Port:** The data service center’s listening port.
- Device ID:** The router’s identity ID.
- Device Number:** The router’s phone number.
- Heartbeat Interval:** The time interval to send heart beat packet. This item is valid only when you choose UDP(DTU) or TCP(DTU) protocol type.
- TCP Server Listen Port:** This item is valid when Protocol Type is “TCP Server”
- Custom Heartbeat Packet :** This item is valid when Protocol Type is “TCST”
- Custom Registration Packets:** This item is valid when Protocol Type is “TCST”

3.3.10 Administration

3.3.10.1 Management

The Management screen allows you to change the router's settings. On this page you will find most of the configurable items of the router code.

Router Password

Router Username	●●●●●●●●●●●●●●●●
Router Password	●●●●●●●●●●●●●●●●
Re-enter to confirm	●●●●●●●●●●●●●●●●

The new password must not exceed 46 characters in length and must not include any spaces. Enter the new password a second time to confirm it.

Note :

Default username is root.

It is strongly recommended that you change the factory default password of the router, which is admin. All users who try to access the router's web-based utility or Setup Wizard will be prompted for the router's password.

Web Access

This feature allows you to manage the router using either HTTP protocol or the HTTPS protocol. If you choose to disable this feature, a manual reboot will be required. You can also activate or not the router information web page. It's now possible to password protect this page (same username and password than above).

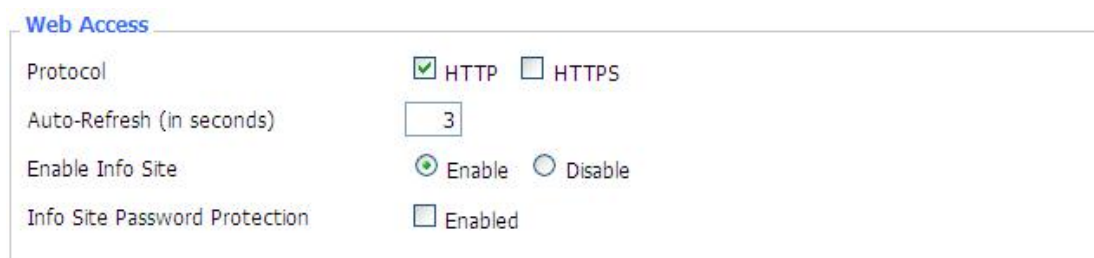

Protocol : This feature allows you to manage the router using either HTTP protocol or the HTTPS protocol

Auto-Refresh : Adjusts the Web GUI automatic refresh interval. 0 disables this feature completely

Enable Info Site : Enable or disable the login system information page

Info Site Password Protection : Enable or disable the password protection feature of the system information page

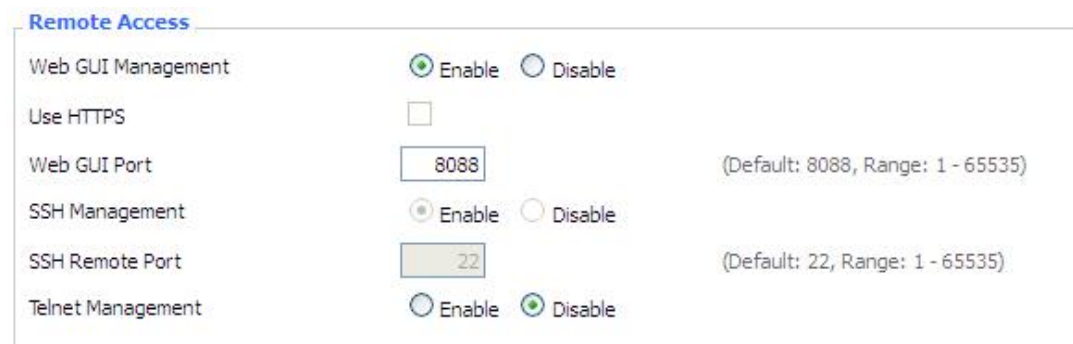

Remote Access : This feature allows you to manage the router from a remote location, via the Internet. To disable this feature, keep the default setting, Disable. To enable this feature, select Enable, and use the specified port (default is 8080) on your PC to remotely manage the router. You must also change the router's default password to one of your own, if you haven't already.

To remotely manage the router, enter `http://xxx.xxx.xxx.xxx:8080` (the x's represent the router's Internet IP address, and 8080 represents the specified port) in your web browser's address field. You will be asked for the router's password.

If you use https you need to specify the url as `https://xxx.xxx.xxx.xxx:8080` (not all firmwares does support this without rebuilding with SSL support).

SSH Management: You can also enable SSH to remotely access the router by Secure Shell. Note that SSH daemon needs to be enable in Services page.

Note :

If the Remote Router Access feature is enabled, anyone who knows the router's Internet IP address and password will be able to alter the router's settings.

Telnet Management : Enable or disable remote Telnet function

Cron

Cron Enable Disable

Additional Cron Jobs

Cron : The cron subsystem schedules execution of Linux commands. You'll need to use the command line or startup scripts to actually use this.

Language Selection

Language

Language : Set up the router page shows the type of language, including simplified Chinese and English.

Device Management

Device Management Enable Disable

Device Management Server IP

Device Management Server Listen Port (Default: 40001, Range: 1 - 65535)

Heart Interval (Default: 60Sec, Range: 1 - 999)

Device Number

Device Phone Number

Device Type Description

Remote Upgrade: custom-developed remote management server for this station Router monitoring and management, configuration parameters, WIFI advertising updates.

3.3.10.2 Keep Alive

Schedule Boot&Shutdown

Schedule Boot&Shutdown

Schedule Boot&Shutdown Enable Disable

Match Day Weekday Days Weekdays

Shutdown Time :

Shutdown Date : : :

Boot Time :

Boot Date : : :

The user can set the startup or shutdown time:

For example, the user want to set the start time at 8:07 and boot time at 9:07.

Schedule Boot&Shutdown

Schedule Boot&Shutdown Enable Disable

Match Day Weekday Days Weekdays

Shutdown Time 08 : 07

Shutdown Date * 01 Sunday Sunday

Boot Time 09 : 07

Boot Date * 01 Sunday Sunday

Schedule Reboot

Schedule Reboot

Schedule Reboot Enable Disable

Interval (in seconds) 3600

At a set Time 00 : 00 Sunday

You can schedule regular reboots for the Router :

Regularly after xxx seconds.

At a specific date time each week or everyday.

Note :

For date based reboots Cron must be activated. See Management for Cron activation.

3.3.10.3 Commands

Commands : You are able to run command lines directly via the Webinterface.

Command Shell

Commands

Run Commands Save Startup Save Shutdown Save Firewall Save Custom Script

Run Command : You can run command lines via the web interface. Fill the text area with your command and click Run Commands to submit.

Startup : You can save some command lines to be executed at startup's router. Fill the text area with commands (only one command by row) and click Save Startup.

Shutdown : You can save some command lines to be executed at shutdown's router. Fill the text area with commands (only one command by row) and click Save Shutdown.

Firewall : Each time the firewall is started, it can run some custom iptables instructions. Fill the

text area with firewall's instructions (only one command by row) and click Save Firewall.

Custom Script : Custom script is stored in /tmp/custom.sh file. You can run it manually or use cron to call it. Fill the text area with script's instructions (only one command by row) and click Save Custom Script.

3.3.10.4 Factory Defaults



Reset router settings : Click the Yes button to reset all configuration settings to their default values. Then click the Apply Settings button.

Note :

Any settings you have saved will be lost when the default settings are restored. After restoring the router is accessible under the default IP address 192.168.1.1 and the default password admin.

3.3.10.5 Firmware Upgrade

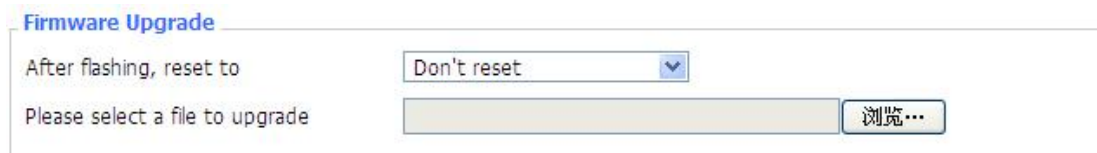

Firmware Upgrade : New firmware versions are posted at www.four-faith.com and can be downloaded. If the Router is not experiencing difficulties, then there is no need to download a more recent firmware version, unless that version has a new feature that you want to use.

Note :

When you upgrade the Router's firmware, you lose its configuration settings, so make sure you write down the Router settings before you upgrade its firmware.

To upgrade the Router's firmware:

1. Download the firmware upgrade file from the website.
2. Click the Browse... button and chose the firmware upgrade file.
3. Click the Upgrade button and wait until the upgrade is finished.

Note :

Upgrading firmware may take a few minutes.

Do not turn off the power or press the reset button!

After flashing, reset to : If you want to reset the router to the default settings for the firmware version you are upgrading to, click the Firmware Defaults option.

3.3.10.6 Backup

Backup Configuration

Backup Settings

Click the "Backup" button to download the configuration backup file to your computer.

Restore Configuration

Restore Settings

Please select a file to restore

WARNING

Only upload files backed up using this firmware and from the same model of router.
Do not upload any files that were not created by this interface!

Backup Settings : You may backup your current configuration in case you need to reset the router back to its factory default settings. Click the Backup button to backup your current configuration.

Restore Settings : Click the Browse... button to browse for a configuration file that is currently saved on your PC. Click the Restore button to overwrite all current configurations with the ones in the configuration file.

Note :

Only restore configurations with files backed up using the same firmware and the same model of router.

3.3.11 Status

3.3.11.1 Router

System	
Router Name	Four-Faith
Router Model	Four-Faith Router
Firmware Version	F393x v2.0 (Jul 17 2012 19:40:10) std - build 235
MAC Address	<u>00:0C:43:30:52:78</u>
Host Name	
WAN Domain Name	
LAN Domain Name	
Current Time	Wed, 18 Jul 2012 11:42:04
Uptime	28 min

Router Name: name of the router, setting→basic setting to modify

Router Model: model of the router, unavailable to modify

Firmware Version: software version information

MAC Address: MAC address of WAN, setting→Clone MAC Address to modify

Host Name: host name of the router, setting→basic setting to modify

WAN Domain Name: domain name of WAN, setting→basic setting to modify

LAN Domain Name: domain name of LAN, unavailable to modify

Current Time: local time of the system

Uptime: operating uptime as long as the system is powered on



Total Available: the room for total available of RAM (that is physical memory minus some reserve and the kernel of binary code bytes)

Free: free memory, the router will reboot if the memory is less than 500kB

Used: used memory, total available memory minus free memory

Buffers: used memory for buffers,

Cached: the memory used by high-speed cache memory

Active: active use of buffer or cache memory page file size

Inactive: not often used in a buffer or cache memory page file size



IP Filter Maximum Ports: preset is 4096, available to re-management

Active IP Connections: real time monitor active IP connections of the system, click to see the table as blow:

No.	Protocol	Timeout (s)	Source Address	Remote Address	Service Name	State
1	TCP	60	192.168.1.120	192.168.1.1		80 TIME_WAIT
2	TCP	30	192.168.1.120	192.168.1.1		80 TIME_WAIT
3	TCP	65	192.168.1.120	192.168.1.1		80 TIME_WAIT
4	TCP	96	192.168.1.120	192.168.1.1		80 TIME_WAIT
5	TCP	99	192.168.1.120	192.168.1.1		80 TIME_WAIT
6	TCP	70	192.168.1.120	192.168.1.1		80 TIME_WAIT
7	TCP	74	192.168.1.120	192.168.1.1		80 TIME_WAIT
8	TCP	115	192.168.1.120	192.168.1.1		80 TIME_WAIT
9	TCP	84	192.168.1.120	192.168.1.1		80 TIME_WAIT
10	TCP	3599	192.168.1.120	192.168.1.1		80 ESTABLISHED
11	TCP	3599	192.168.1.120	192.168.1.1		80 ESTABLISHED
12	TCP	108	192.168.1.120	192.168.1.1		80 TIME_WAIT
13	TCP	3600	192.168.1.120	192.168.1.1		80 ESTABLISHED
14	TCP	93	192.168.1.120	192.168.1.1		80 TIME_WAIT
15	TCP	102	192.168.1.120	192.168.1.1		80 TIME_WAIT
16	TCP	74	192.168.1.120	192.168.1.1		80 TIME_WAIT
17	TCP	3599	192.168.1.120	192.168.1.1		80 ESTABLISHED
18	TCP	15	192.168.1.120	192.168.1.1		80 TIME_WAIT
19	TCP	25	192.168.1.120	192.168.1.1		80 TIME_WAIT
20	TCP	90	192.168.1.120	192.168.1.1		80 TIME_WAIT
21	UDP	26	192.168.8.119	255.255.255.255	1947	UNREPLIED
22	TCP	77	192.168.1.120	192.168.1.1		80 TIME_WAIT
23	TCP	35	192.168.1.120	192.168.1.1		80 TIME_WAIT
24	TCP	74	192.168.1.120	192.168.1.1		80 TIME_WAIT
25	TCP	40	192.168.1.120	192.168.1.1		80 TIME_WAIT
26	TCP	3599	192.168.1.120	192.168.1.1		80 ESTABLISHED
27	TCP	74	192.168.1.120	192.168.1.1		80 TIME_WAIT
28	TCP	74	192.168.1.120	192.168.1.1		80 TIME_WAIT
29	TCP	4	192.168.1.120	192.168.1.1		80 TIME_WAIT
30	UDP	31	192.168.8.160	224.0.0.1	9166	UNREPLIED
31	TCP	74	192.168.1.120	192.168.1.1		80 TIME_WAIT

Active IP Connections: total active IP connections

Protocol: connection protocol

Timeouts: connection timeouts, unit is second

Source Address: source IP address

Remote Address: remote IP address

Service Name: connecting service port

Status: displayed status

3.3.11.2 WAN

Connection Type Automatic Configuration - DHCP

Connection Uptime Not available

Connection Type: disabled, static IP, automatic configuration-DHCP, 3G Link 1, 3G Link 2

Connection Uptime: connecting uptime; If disconnect, display Not available

IP Address 0.0.0.0

Subnet Mask 0.0.0.0

Gateway 0.0.0.0

DNS 1

DNS 2

DNS 3

IP Address: IP address of router WAN

Subnet Mask: subnet mask of router WAN

Gateway: the gateway of router WAN

DNS1, DNS2, DNS3: DNS1/DNS2/DNS3 of router WAN

Remaining Lease Time 0 days 23:38:43

DHCP Release

DHCP Renew

Remaining Lease Time: remaining lease time of IP address in DHCP way

DHCP Release: release DHCP address

DHCP Renew: renew IP address in DHCP way, default is 1 day

Login Status

Disconnected

Connect

Login Status: connection status of WAN

Disconnection: disconnect

Connection: connect

Module Type

ANYDATA-EVDO MODULE



Signal Status

-51 dBm

Network

CDMA/HDR

Module Type: module type in 3G/UMTS way

Signal Status: signal intensity of the module in 3G/UMTS way

Network: network type of the module in 3G/UMTS way

Total Traffic

Incoming (MBytes)	0
Outgoing (MBytes)	0

Traffic by Month

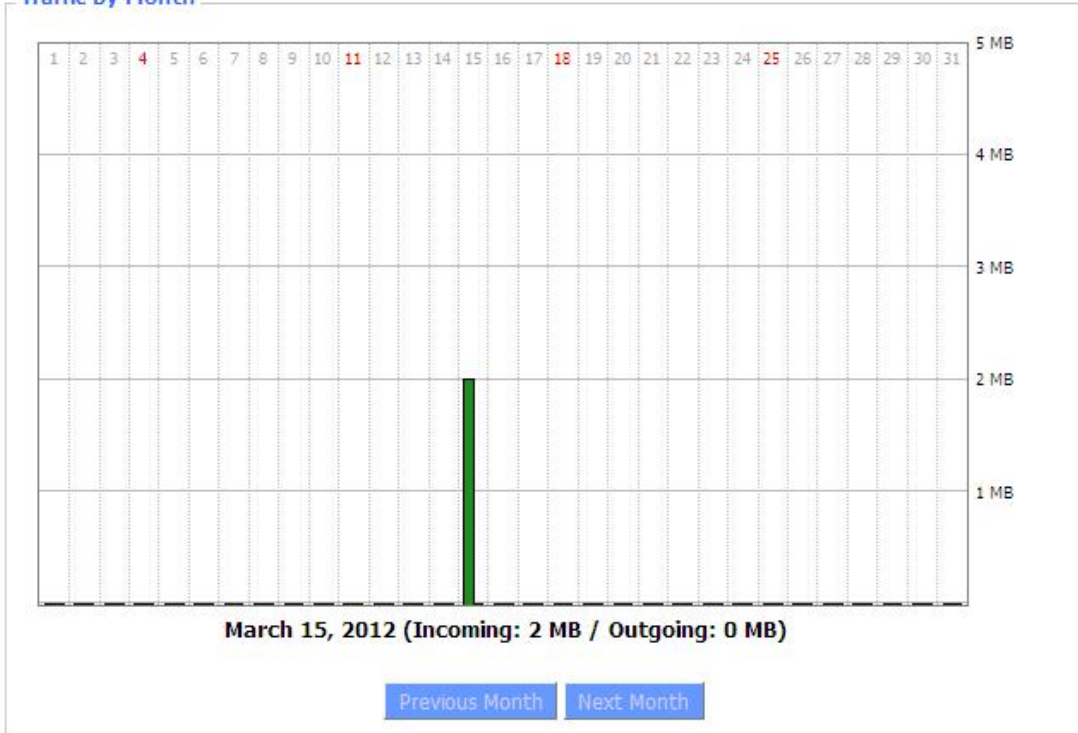

Total Flow: flow from power-off last time until now statistics, download and upload direction

Monthly Flow: the flow of a month, unit is MB

Last Month: the flow of last month

Next Month: the flow of next month

Data Administration

Backup Restore Delete

Backup: backup data administration

Restore: restore data administration

Delete: delete data administration

3.3.11.3 BKUP WAN

Connection Type	Automatic Configuration - DHCP
Connection Uptime	Not available

Connection Type: disabled, static IP, automatic configuration-DHCP, 3G Link 1, 3G Link 2

Connection Uptime: connecting uptime; If disconnect, display Not available

IP Address	0.0.0.0
Subnet Mask	0.0.0.0
Gateway	0.0.0.0
DNS 1	
DNS 2	
DNS 3	

IP Address: IP address of router WAN

Subnet Mask: subnet mask of router WAN

Gateway: the gateway of router WAN

DNS1, DNS2, DNS3: DNS1/DNS2/DNS3 of router WAN

Remaining Lease Time 0 days 23:38:43

DHCP Release

DHCP Renew

Remaining Lease Time: remaining lease time of IP address in DHCP way

DHCP Release: release DHCP address

DHCP Renew: renew IP address in DHCP way, default is 1 day

Login Status

Disconnected

Connect

Login Status: connection status of WAN

Disconnection: disconnect

Connection: connect

Module Type

ANYDATA-EVDO MODULE



Signal Status

-51 dBm

Network

CDMA/HDR

Module Type: module type in 3G/UMTS way

Signal Status: signal intensity of the module in 3G/UMTS way

Network: network type of the module in 3G/UMTS way

Total Traffic

Incoming (MBytes)	0
Outgoing (MBytes)	0

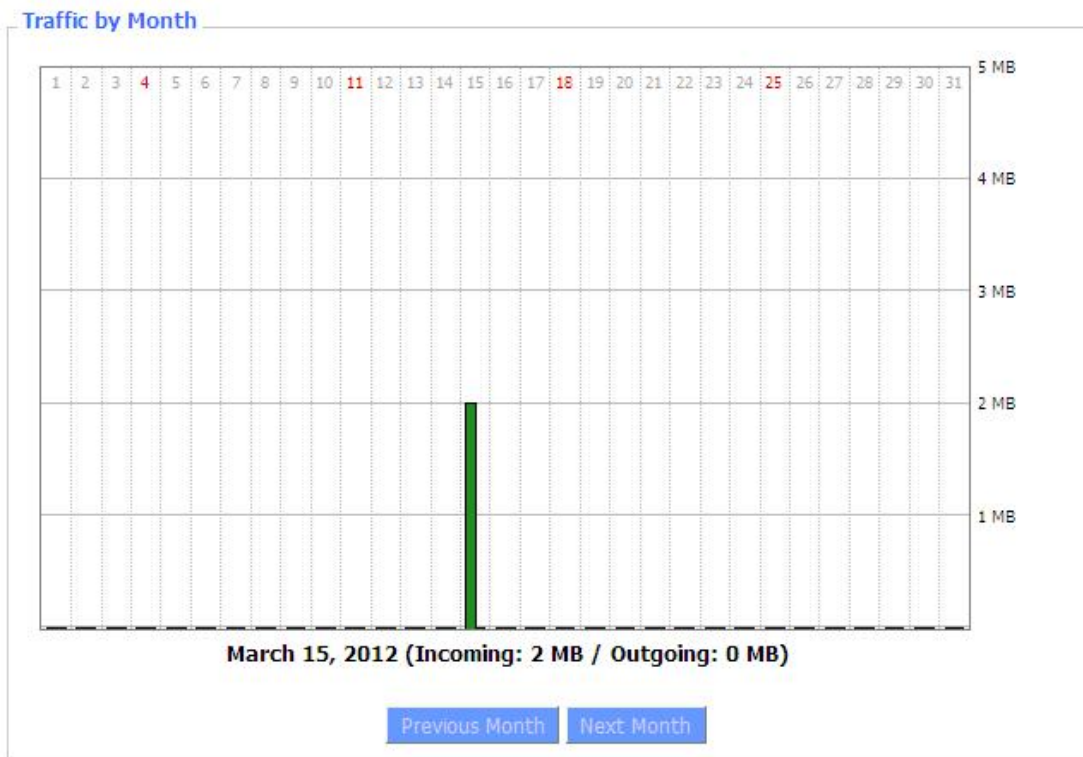

Total Flow: flow from power-off last time until now statistics, download and upload direction

Monthly Flow: the flow of a month, unit is MB

Last Month: the flow of last month

Next Month: the flow of next month

Data Administration

Backup Restore Delete

Backup: backup data administration

Restore: restore data administration

Delete: delete data administration

3.3.11.4 LAN

LAN Status

MAC Address	00:0C:43:30:52:77
IP Address	192.168.1.1
Subnet Mask	255.255.255.0
Gateway	0.0.0.0
Local DNS	0.0.0.0

MAC Address: MAC Address of the LAN port ethernet

IP Address: IP Address of the LAN port

Subnet Mask: Subnet Mask of the LAN port

Gateway: Gateway of the LAN port

Local DNS: DNS of the LAN port

Active Clients

Host Name	IP Address	MAC Address	Conn. Count	Ratio [4096]
*	192.168.1.120	<u>10:78:D2:98:C9:46</u>	57	1%

Host Name: host name of LAN client

IP Address: IP address of the client

MAC Address: MAC address of the client

Conn. Count: connection count caused by the client

Ratio: the ratio of 4096 connection

Dynamic Host Configuration Protocol

DHCP Status

DHCP Server	Enabled
DHCP Daemon	uDHCpd
Start IP Address	192.168.1.100
End IP Address	192.168.1.149
Client Lease Time	1440 minutes

DHCP Server: enable or disable the router work as a DHCP server

DHCP Daemon: the agreement allocated using DHCP including DNSMasq and uDHCpd

Starting IP Address: the starting IP Address of the DHCP server's Address pool

Ending IP Address: the ending IP Address of the DHCP server's Address pool

Client Lease Time: the lease time of DHCP client

DHCP Clients

Host Name	IP Address	MAC Address	Client Lease Time	Delete
PC-201011161332	192.168.1.142	<u>00:21:5C:33:4D:29</u>	1 day 00:00:00	
jack-lincw	192.168.1.117	<u>44:37:E6:3F:45:54</u>	1 day 00:00:00	
*	192.168.1.149	<u>00:0C:E7:00:00:00</u>	1 day 00:00:00	

Host Name: host name of LAN client

IP Address: IP address of the client

MAC Address: MAC address of the client

Expires: the expiry the client rents the IP address

Connected PPPOE Clients

Interface	User Name	Local IP	Delete
ppp0	hometest	192.168.10.10	

Interface: the interface assigned by dial-up system

User Name: user name of PPPoE client

Local IP: IP address assigned by PPPoE client

Delete: click to delete PPPoE client

Connected L2TP Server

Interface	Local IP	Remote IP	Delete
ppp0	172.168.8.2	172.168.8.1	

Interface: the interface assigned by dial-up system

Local IP: tunnel IP address of local L2TP

Remote IP: tunnel IP address of L2TP server

Delete: click to disconnect L2TP

Connected L2TP Clients

Interface	User Name	Local IP	Remote IP	Delete
ppp1	hometest	192.168.50.2	120.42.46.98	

Interface: the interface assigned by dial-up system

User Name: user name of the client

Local IP: tunnel IP address of L2TP client

Remote IP: IP address of L2TP client

Delete: click to delete L2TP client

Connected PPTP Server

Interface	Local IP	Remote IP	Delete
ppp0	172.168.8.2	172.168.8.1	

Interface: the interface assigned by dial-up system

Local IP: tunnel IP address of local PPTP

Remote IP: tunnel IP address of PPTP server

Delete: click to disconnect PPTP

Connected PPTP Clients

Interface	User Name	Local IP	Remote IP	Delete
ppp1	hometest	192.168.5.1	120.42.46.98	

Interface: the interface assigned by dial-up system

User Name: user name of the client

Local IP: tunnel IP address of PPTP client

Remote IP: IP address of PPTP client

Delete: click to delete PPTP client

3.3.11.5 Wireless

Wireless Status	
MAC Address	00:0C:43:30:52:79
Radio	Radio is On
Mode	AP
Network	Mixed
SSID	four-faith
Channel	6 (2437 MHz)
TX Power	71 mW
Rate	72 Mb/s
Encryption - Interface w10	Disabled
PPTP Status	Disconnected

MAC Address: MAC address of wireless client

Radio: display whether radio is on or not

Mode: wireless mode

Network: wireless network mode

SSID: wireless network name

Channel: wireless network channel

TX Power: reflection power of wireless network

Rate: reflection rate of wireless network

Encryption-Interface w10: enable or diasbal Encryption-Interface w10

PPTP Status: show wireless pptp status

Wireless Packet Info		
Received (RX)	91125 OK, no error	100%
Transmitted (TX)	11957 OK, no error	100%

Received (RX): received data packet

Transmitted (TX): transmitted data packet

Wireless Nodes								
Clients								
MAC Address	Interface	Uptime	TX Rate	RX Rate	Signal	Noise	SNR	Signal Quality
- None -								

MAC Address: MAC address of wireless client

Interface: interface of wireless client

Uptime: connecting uptime of wireless client

TX Rate: transmit rate of wireless client

RX Rate: receive rate of wireless client

Signal: the signal of wireless client

Noise: the noise of wireless client

SNR: the signal to noise ratio of wireless client

Signal Quality: signal quality of wireless client

Neighbor's Wireless Networks										
SSID	Mode	MAC Address	Channel	Rssi	Noise	beacon	Open	dtim	Rate	Join Site
tzt-3g	Unknown	00:aa:bb:cc:dd:14	2	-5	-95	0	No	0	54(b/g)	Join
four-faith	Unknown	00:0c:43:30:52:79	6	-24	-95	0	No	0	300(b/g/n)	Join
ff-old	AP	00:13:10:09:56:92	6	-55	-95	0	No	0	54(b/g)	Join

Neighbor's Wireless Network: display other networks nearby

SSID: the name of wireless network nearby

Mode: operating mode of wireless network nearby

MAC Address: MAC address of the wireless nearby

Channel: the channel of the wireless nearby

Rssi: signal intensity of the wireless nearby

Noise: the noise of the wireless nearby

Beacon: signal beacon of the wireless nearby

Open: the wireless nearby is open or not

Dtim: delivery traffic indication message of the wireless nearby

Rate: speed rate of the wireless nearby

Join Site: click to join wireless network nearby

3.3.11.6 Bandwidth



Bandwidth Monitoring-LAN Graph

abscissa axis: time

vertical axis: speed rate

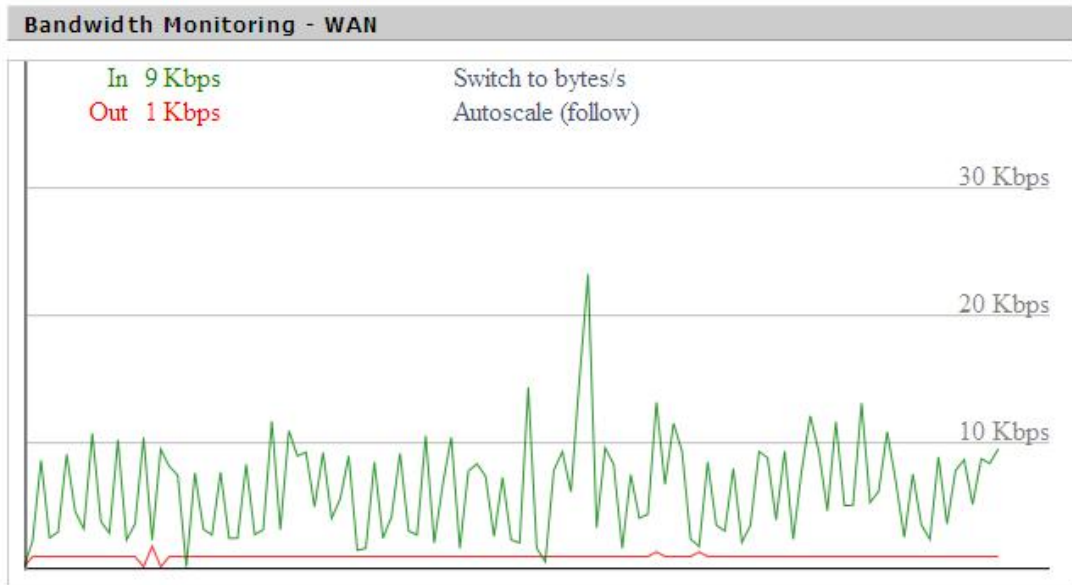

Bandwidth Monitoring-WAN Graph

abscissa axis: time

vertical axis: speed rate

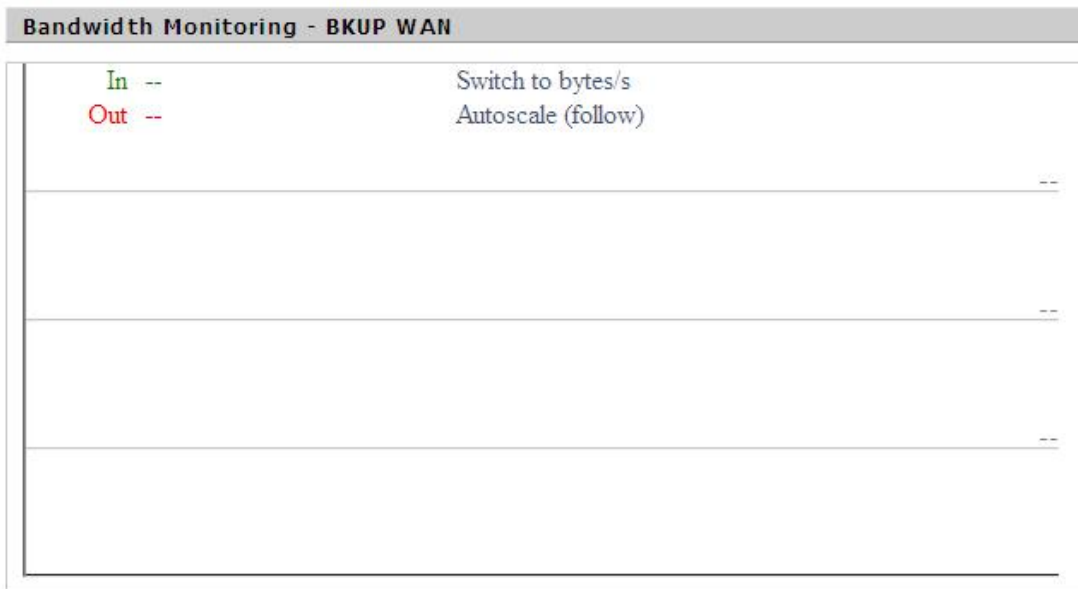

Bandwidth Monitoring-BKUP WAN Graph

abscissa axis: time

vertical axis: speed rate

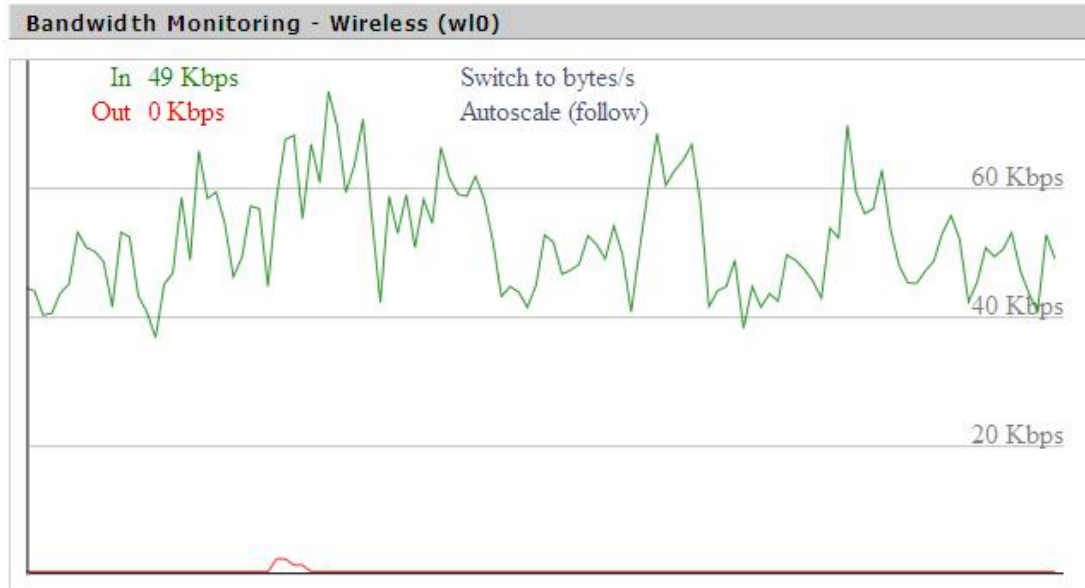

Bandwidth Monitoring-Wireless (W10) Graph

abscissa axis: time

vertical axis: speed rate

3.3.11.7 Sys-Info

Router	
Router Name	Four-Faith
Router Model	Four-Faith Router
LAN MAC	<u>00:0C:43:30:52:77</u>
WAN MAC	<u>00:0C:43:30:52:78</u>
Wireless MAC	<u>00:0C:43:30:52:79</u>
WAN IP	27.149.86.163
BKUP WAN IP	0.0.0.0
LAN IP	192.168.1.1

Router Name: the name of the router

Router Model: the model of the router

LAN MAC: MAC address of LAN port

WAN MAC: MAC address of WAN port

Wireless MAC: MAC address of the wireless

WAN IP: IP address of Main WAN port

BKUP WAN IP: IP address of bkup WAN port

LAN IP: IP address of LAN port

Wireless	
Radio	Radio is On
Mode	AP
Network	Mixed
SSID	four-faith
Channel	6 (2437 MHz)
TX Power	71 mW
Rate	72 Mb/s

Radio: display whether radio is on or not

Mode: wireless mode

Network: wireless network mode

SSID: wireless network name

Channel: wireless network channel

TX Power: reflection power of wireless network

Rate: reflection rate of wireless network

Wireless Packet Info	
Received (RX)	6982 OK, no error
Transmitted (TX)	1498 OK, no error

Received (RX): received data packet

Transmitted (TX): transmitted data packet

Wireless								
Clients								
MAC Address	Interface	Uptime	TX Rate	RX Rate	Signal	Noise	SNR	Signal Quality
- None -								

MAC Address: MAC address of wireless client

Interface: interface of wireless client

Uptime: connecting uptime of wireless client

TX Rate: transmit rate of wireless client

RX Rate: receive rate of wireless client

Signal: the signal of wireless client

Noise: the noise of wireless client

SNR: the signal to noise ratio of wireless client

Signal Quality: signal quality of wireless client

Services

DHCP Server	Enabled
ff-radauth	Disabled
USB Support	Disabled

DHCP Server: enabled or disabled

ff-radauth: enabled or disabled

USB Support: enabled or disabled

Memory

Total Available	28.2 MB / 32.0 MB
Free	11.2 MB / 28.2 MB
Used	17.0 MB / 28.2 MB
Buffers	1.8 MB / 17.0 MB
Cached	6.3 MB / 17.0 MB
Active	1.5 MB / 17.0 MB
Inactive	0.8 MB / 17.0 MB

Total Available: the room for total available of RAM (that is physical memory minus some reserve and the kernel of binary code bytes)

Free: free memory, the router will reboot if the memory is less than 500kB

Used: used memory, total available memory minus free memory

Buffers: used memory for buffers, total available memory minus allocated memory

Cached: the memory used by high-speed cache memory

Active: Active use of buffer or cache memory page file size

Inactive: Not often used in a buffer or cache memory page file size

DHCP

DHCP Clients

Host Name	IP Address	MAC Address	Expires
*	192.168.1.143	xx:xx:xx:xx:DD:45	1 day 00:00:00
four-488e1df5fa	192.168.1.125	xx:xx:xx:xx:D8:F7	1 day 00:00:00
Mycenae-PC	192.168.1.116	xx:xx:xx:xx:5E:30	1 day 00:00:00

Host Name: host name of LAN client

IP Address: IP address of the client

MAC Address: MAC address of the client

Expires: the expiry the client rents the IP address

Chapter 4 Appendix

The following steps describe how to setup Windows XP Hyper Terminal.

1. Press “Start”→”Programs”→”Accessories”→”Communications”→”Hyper Terminal”

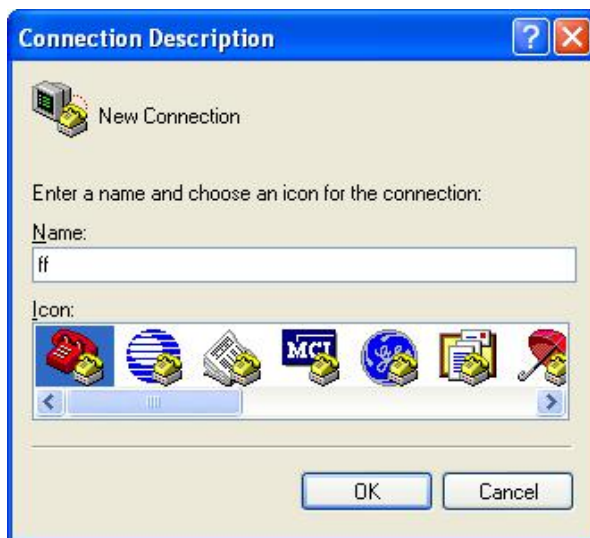

2. Input connection name, choose “OK”
3. Choose the correct COM port which connects to modem, choose “OK”



4. Configure the serial port parameters as following, choose “OK”

Bits per second: 115200

Data bits: 8

Parity: None

Stop bits: 1

Flow control: None

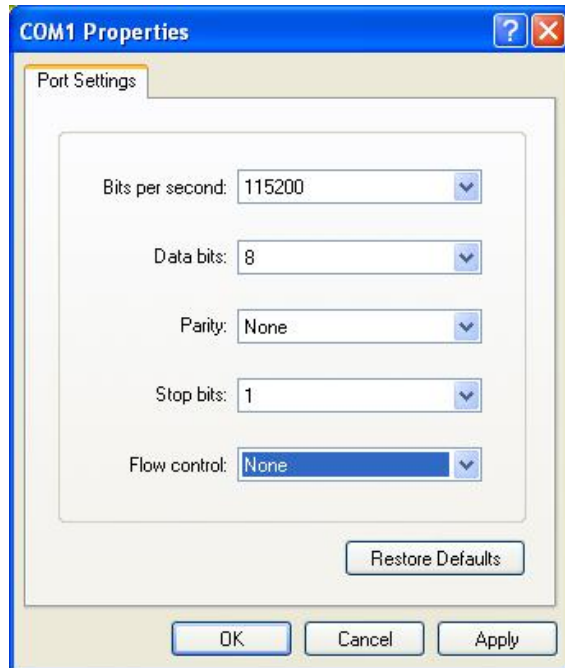

5. Complete Hyper Terminal operation, It runs as following

