

F2X16 Series User Manual	Product Version	Page
	V1.0	
	Product Name: F2x16	Total: 33

# F2X16 Series User Manual

The user manual is suitable for the following model:

Model	Product Type
F2116	GPRS IP MODEM
F2216	CDMA IP MODEM
F2416	WCDMA IP MODEM
F2616	EVDO IP MODEM
F2716	TDD-LTE IP MODEM
F2816	FDD-LTE IP MODEM
F2A16	LTE IP MODEM





## Files Revised Record

Date	Version	Remark	Author
2016.6.1	V1.0	build	zxz

## Copyright Notice

All contents in the files are protected by copyright law, and all copyrights are reserved by Xiamen Four-Faith Communication Technology Co., Ltd. Without written permission, all commercial use of the files from Four-Faith are forbidden, such as copy, distribute, reproduce the files, etc., but non-commercial purpose, downloaded or printed by individual (all files shall be not revised, and the copyright and other proprietorship notice shall be reserved) are welcome.

## Trademark Notice

Four-Faith、四信、、、 are all registered trademarks of Xiamen Four-Faith Communication Technology Co., Ltd., illegal use of the name of Four-Faith, trademarks and other marks of Four-Faith is forbidden, unless written permission is authorized in advance.

# Contents

Chapter 1 Brief Introduction of Product.....	4
1.1 General.....	4
1.2 Features and Benefits.....	4
1.3 Working Principle.....	5
1.4 Specifications.....	6
Chapter 2 Installation Introduction.....	8
2.1 General.....	8
2.2 Encasement List.....	8
2.3 Installation and Cable Connection.....	9
2.4 Power.....	12
2.5 Indicator Lights Introduction.....	12
Chapter 3 Configuration.....	13
3.1 Configuration Connection.....	13
3.2 Configuration Introduction.....	13
3.3 IP Modem's Parameters Configuration.....	14
3.3.1 Run the Configure Tools.....	14
3.3.2 Re-Power IP Modem.....	15
3.3.3 Work Mode.....	15
3.3.4 Data Service Center Settings.....	21
3.3.5 Serial port.....	23
3.3.6 Dial.....	25
3.3.7 Global Parameters.....	26
3.3.8 Device Manage.....	27
3.3.9 Miscellaneous.....	29
Appendix.....	30

## Chapter 1 Brief Introduction of Product

### 1.1 General

F2X16 series IP MODEM is a kind of cellular terminal device that provides data transfer by public cellular network.

It adopts high-powered industrial 32 bits CPU and embedded real time operating system. It supports RS232 and RS485 (or RS422) port that can conveniently and transparently connect one device to a cellular network, allowing you to connect to your existing serial devices with only basic configuration. It has low power consumption states in which the power consumption could be lower than 5mA@12VDC. It has compatible digital I/O channel, ADC, input pulse counter and pulse wave output function.

It has been widely used on M2M fields, such as intelligent transportation, smart grid, industrial automation, telemetry, finance, POS, water supply, environment protection, post, weather, and so on.

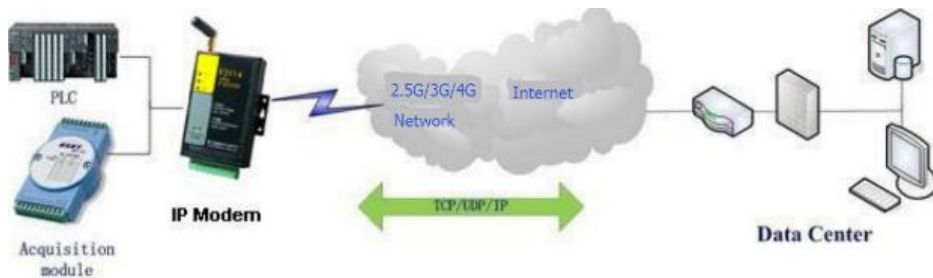

Figure 1-1 IP MODEM Application Topology

### 1.2 Features and Benefits

#### Design for Industrial Application

- ◆ High-powered industrial cellular module
- ◆ High-powered industrial 32 bits CPU
- ◆ Support low power consumption mode, including multi-sleep and trigger modes to reduce the power dissipation farthest
- ◆ Housing: iron, providing IP30 protection.
- ◆ Power range: DC 5~36V

#### Stability and Reliability

- ◆ Support hardware and software WDT
- ◆ Support auto recovery mechanism, including online detect, auto redial when offline to make it always online
- ◆ RS232/RS485/RS422 port: 15KV ESD protection
- ◆ SIM/UIM port: 15KV ESD protection

- ◆ Power port: reverse-voltage and overvoltage protection
- ◆ Antenna port: lightning protection(optional)

#### Standard and Convenience

- ◆ Adopt terminal block interface, convenient for industrial application
- ◆ Support standard RS232 and RS485(or RS422) port that can connect to serial devices directly
- ◆ TTL logic level RS232 interface can be customized
- ◆ Support intellectual mode, enter into communication state automatically when powered
- ◆ Provide management software for remote management
- ◆ Support several work modes
- ◆ Convenient configuration and maintenance interface

#### High-performance

- ◆ Support TCP server and support multi TCP client connection(optional)
- ◆ Support double data centers, one main and another backup
- ◆ Supply 2 I/O channels, compatible 2 pulse wave output channels, 2 analog inputs and one pulse input counters.
- ◆ Support multi data centers and it can support 5 data centers at the same time
- ◆ Support multi online trigger ways, including SMS, ring and data. Support link disconnection when timeout
- ◆ Support dynamic domain name(DDNS) and IP access to data center
- ◆ Design with standard TCP/IP protocol stack
- ◆ Support APN/VPDN

## 1.3 Working Principle

The principle chart of the IP MODEM is as following.

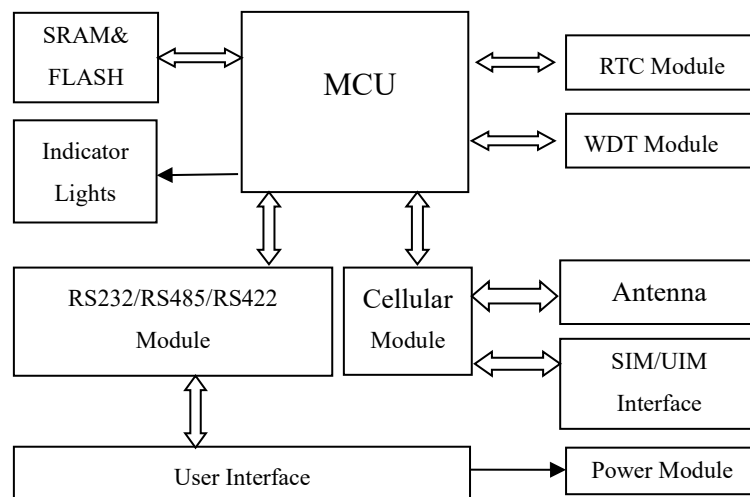

Figure1-2 IP Modem principle chart

## 1.4 Specifications

### Cellular Specification

Standard and Band	Bandwidth	TX power	RX Sensitivity
<b>F2116 GPRS IP MODEM</b>			
EGSM900/GSM1800MHz, GSM850/900/1800/1900MHz(optional) Compliant to GSM phase 2/2+ GPRS class 10, class 12(optional)	85.6Kbps	GSM850/900 : <33dBm  GSM1800/1900 : <30dBm	<-107 dBm
<b>F2216 CDMA IP MODEM</b>			
CDMA2000 1xRTT 800MHz 800/1900MHz(optional) 450MHz(optional)	153.6Kbps	<30dBm	<-104 dBm
<b>F2416 WCDMA&amp;HSDPA&amp;HSUPA IP MODEM</b>			
UMTS/WCDMA/HSDPA/HSUPA 850/1900/2100MHz, 850/900/1900/2100MHz(optional) GSM850/900/1800/1900MHz GPRS/EDGE CLASS 12	HSDPA:7.2Mbps(DL)  HSUPA:5.76Mbps(UL)  UMTS:384Kbps (DL/UL)	<24dBm	<-109 dBm
<b>F2616 CDMA2000 1X EVDO IP MODEM</b>			
CDMA2000 1X EVDO Rev A 800MHz,800/1900MHz(optional) 450MHz (optional) CDMA2000 1X RTT, IS-95 A/B	3.1Mbps(DL),1.8Mbps(UL)	<23dBm	<-104 dBm
<b>F2716 TDD-LTE IP MODEM</b>			
TDD-LTE 2600/1900/2300MHz(Band 38/39/40) 800/1400/1800MHz(Band 27/61/62) (optional) TD-SCDMA 2010/1900MHz(A/F, Band 34/39) GSM/GPRS/EDGE 900/1800/1900MHz	TDD-LTE: 61Mbps(DL),18Mbps(UL)  TD-SCDMA: 2.2Mbps(DL), 2.8Mbps(UL)	<23dBm	<-97 dBm
<b>F2816 FDD-LTE IP MODEM</b>			
FDD-LTE 2600/2100/1800/900/800MHz(Band1/3/7/8/20) 700/850/1700/1900/2100MHz (Band 2/4/5/13/17/25)(Optional) DC-HSPA+/HSPA+/HSDPA/HSUPA/WCDMA/UMTS 2100/1900/900/850/800MHz(Band 1/2/5/6/8) EDGE/GPRS/GSM	FDD-LTE: 100Mbps(DL), 50Mbps(UL) HSUPA: 5.76Mbps(UL) HSDPA: 7.2Mbps(DL) UMTS: 384Kbps(DL), 384Kbps(UL) HSPA+: 42Mbps(DL),5.76Mbps(UL)	<23dBm	<-93.3 dBm

850/900/1800/1900MHz			
<b>F2A16 LTE IP MODEM</b>			
TDD-LTE FDD-LTE EVDO WCDMA TD-SCDMA CDMA1X GPRS/EDGE	FDD-LTE: 100Mbps(DL),50Mbps(UL)  TDD-LTE: 61Mbps(DL),18Mbps(UL)  CDMA2000 1X EVDO Rev A: 3.1Mbps(DL),1.8Mbps(UL)  WCDMA: 42Mbps(DL),5.76Mbps(UL)  TD-SCDMA: 4.2Mbps(DL),2.2Mbps(UL)	<23dBm	<-93.3 dBm

**Hardware System**

Item	Content
CPU	Industrial 32 bits CPU
FLASH	512KB(Extendable)
SRAM	256KB

**Interface Type**

Item	Content
Serial	2 RS232 port and 1 RS485(orRS422) port, 15KV ESD protection Data bits: 5, 6 ,7, 8 Stop bits: 1, 1.5, 2 Parity: none, even, odd, space, mark Baud rate: 110~230400 bps
Indicator	"Power", "ACT", "Online"
Antenna	Cellular: Standard SMA female interface, 50 ohm GPS: Standard SMA female interface, 50 ohm lighting protection(optional)
SIM/UIM	Standard 3V/1.8V user card interface, 15KV ESD protection
Power	Terminal block interface, reverse-voltage and overvoltage protection

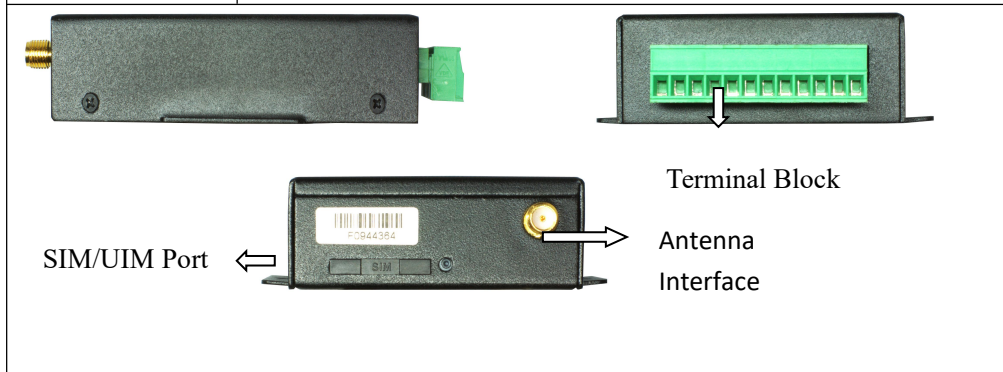

**Power Input**

Item	Content
Standard Power	DC 12V/0.5A
Power Range	DC 5~36V

**Power Consumption**

Working States	Power Consumption
Communication	45~165mA@12VDC (2G:45~55 mA 3G:80~165 mA 4G:75~95mA )  105~365mA@5VDC (2G:105~115 mA 3G:165~365 mA 4G:150~200mA )
Standby	35~50 mA@12VDC      55~105 mA@5VDC
Sleep	3mA@12VDC                      6mA@5VDC

**Physical Characteristics**

Item	Content
Housing	Iron, providing IP30 protection
Dimensions	91x58.5x22 mm
Weight	205g

**Environmental Limits**

Item	Content
Operating Temperature	-35~+75°C (-22~+167°F)
Storage Temperature	-40~+85°C (-40~+185°F)
Operating Humidity	95% ( Non-condensing)

## Chapter 2 Installation Introduction

### 2.1 General

The IP MODEM must be installed correctly to make it work properly.

Warning: Forbid to install the IP MODEM when powered!

### 2.2 Encasement List

Name	Quantity	Remark
IP MODEM host	1	
Cellular Antenna	1	
Power adapter	1	
RS232 data cable	1	optional



RS485 data cable	1	optional
Manual CD	1	
Certification card	1	
Maintenance card	1	

Table 2-1 Encasement List

## 2.3 Installation and Cable Connection

Dimension: (unit: mm)

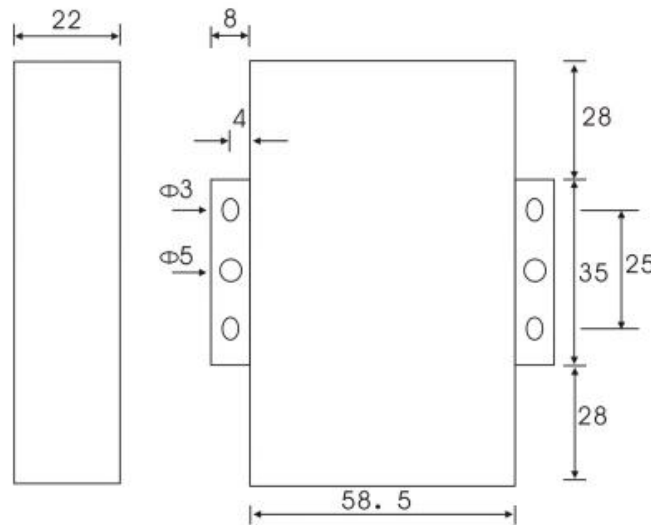

Figure 2-1 Installation Chart

### Installation of SIM/UIM card:

Firstly power off the IP MODEM, and press the out button of the SIM/UIM card outlet with a needle object. Then the SIM/UIM card sheath will flick out at once. Put SIM/UIM card into the card sheath (Pay attention to put the side which has metal point outside), and insert card sheath back to the SIM/UIM card outlet.

**Warning:** Forbid to install SIM/UIM card when powered!

### Installation of antenna:

Screw the SMA male pin of the antenna to the female SMA outlet of the IP MODEM tightly.  
Warning: The antenna must be screwed tightly, or the signal quality of antenna will be influenced!

### User Interface Signal Definition

Pin Number	Signal Name	Default Function	Extensible Function
1	PWR	Power input anode	N/A
2	GND	Power Ground	N/A
3	RX1	RS232 RX	N/A
4	TX1	RS232 TX	N/A
5	GND	System Ground	N/A
6	RX2	RS232 RX	Reserved compatible ADC and

			RS232 RX (TTL logic level)
7	TX2	RS232 TX	Reserved compatible ADC and RS232 TX (TTL logic level)
8	A	RS485 anode	Reserved compatible ADC
9	B	RS485 cathode	Reserved compatible ADC
10	IO1	GPIO	Reserved compatible pulse wave input counter, ADC, and pulse output
11	IO2	GPIO	Reserved compatible pulse wave input counter, ADC, and pulse output
12	ADC1	ADC	N/A



**Installation of cable:**

F2X16 adopts industrial terminal block interface. The recommendatory cable is 28-16AWG. The detail description of standard layout adapter and communication cables as is following:

Adapter (Rating Output 12VDC/0.5A):

Cable Color	Power Output Polarity
Black & White Alternate	Anode
Black	Cathode

RS232 Cable:

Cable Color	Corresponding DB9-M Pin Number
Brown	Pin 2
Blue	Pin 3
Black	Pin 5

RS485 Cable:

Cable Color	Signal definition
Red	RS485(A)
Black	RS485(B)

Power adapter and communication cable connection chart as following,

**Connect via RS232**

**Connect via RS485**

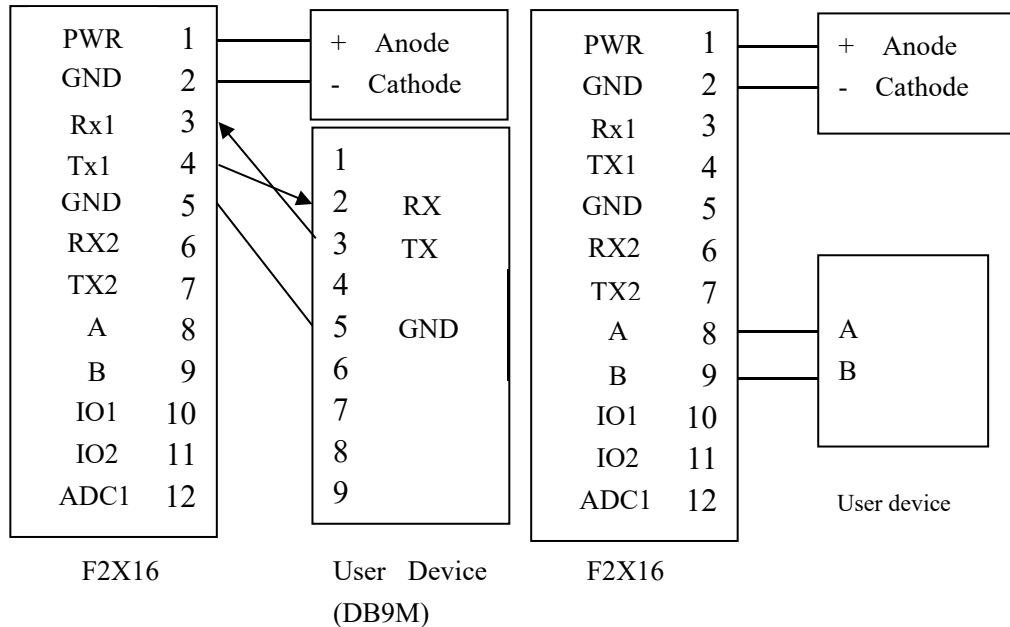

## 2.4 Power

The power range of the IP MODEM is DC 5~36V

**Warning:** When we use other power, we should make sure that the power can supply power above 4W.

We recommend user to use the standard DC 12V/0.5A power adaptor.

## 2.5 Indicator Lights Introduction

The IP MODEM provides three indicator lights: “Power”, “ACT”, “Online”.

Indicator Light	State	Introduction
Power	ON	IP MODEM is powered on
	OFF	IP MODEM is powered off
ACT	BLINK	Data is communicating
	OFF	No data
Online	ON	IP MODEM has logged on network
	OFF	IP MODEM hasn't logged on network

## Chapter 3 Configuration

### 3.1 Configuration Connection

Before configuration, It's necessary to connect the IP MODEM with the configure PC by the shipped RS232 or RS232-485 conversion cable as following.

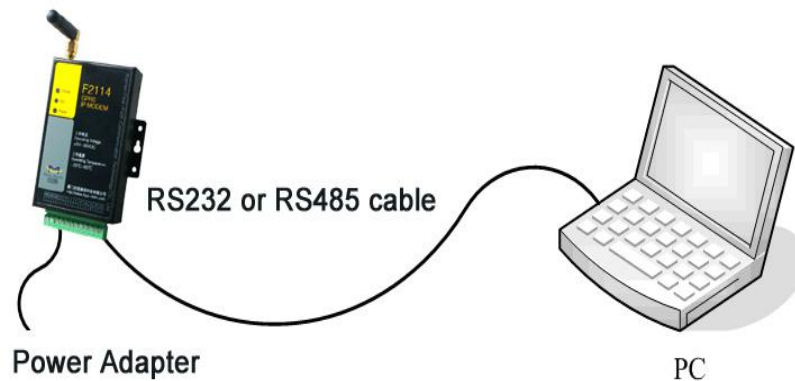

### 3.2 Configuration Introduction

There are two ways to configure the IP MODEM:

**Configuration software tool:** All the settings are configured through the shipped software tool. It's necessary to have one PC to run this tool.

**Extended AT command:** All the settings are configured through AT command, so any device with serial port can configure it. Before configuration with extended AT command, you should make IP MODEM enter configure state. The steps how to make IP MODEM enter configure state, please refer to appendix.

The following describes how to configure IP MODEM with the configure software tool. At the same time, it gives out the corresponding AT command of each configuration item.

## 3.3 IP Modem's Parameters Configuration

### 3.3.1 Run the Configure Tools

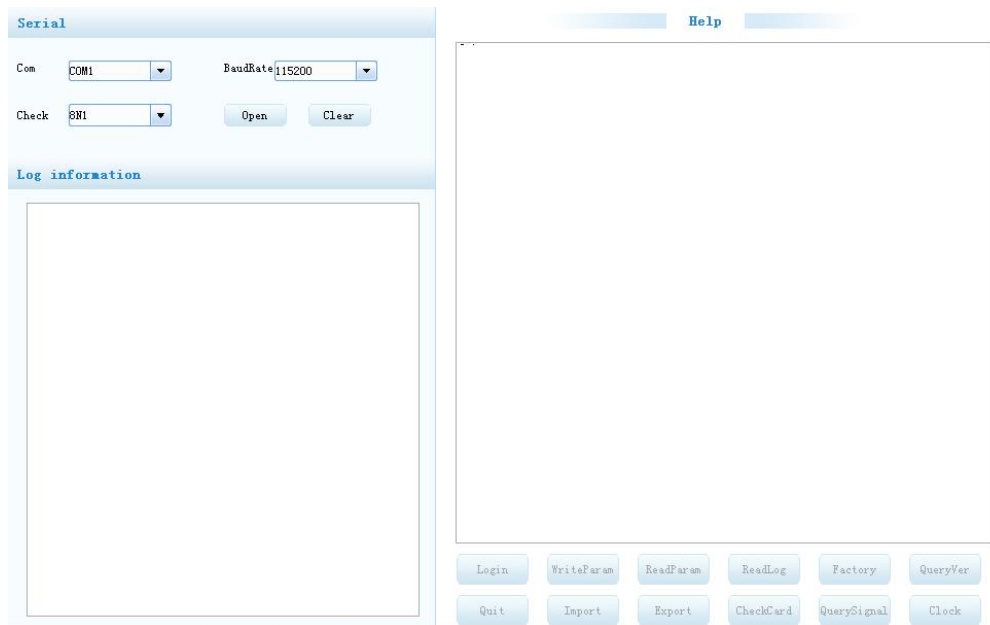

The “Serial” area shows the current serial port settings. To configure IP MODEM, please choose the correct serial port which connects to IP MODEM, and the baud-rate is 115200 with no parity, then open the serial port. If the button text is “Close”, it shows the serial port now has been opened. If the text is “Open”, you should open the port first. When the port opened, the **“Output Info”** column will display

**“Port(COM1) Has Opened, Please Re-Power the IP MODEM,  
Waiting IP MODEM Enter Configure State...”**

### 3.3.2 Re-Power IP Modem

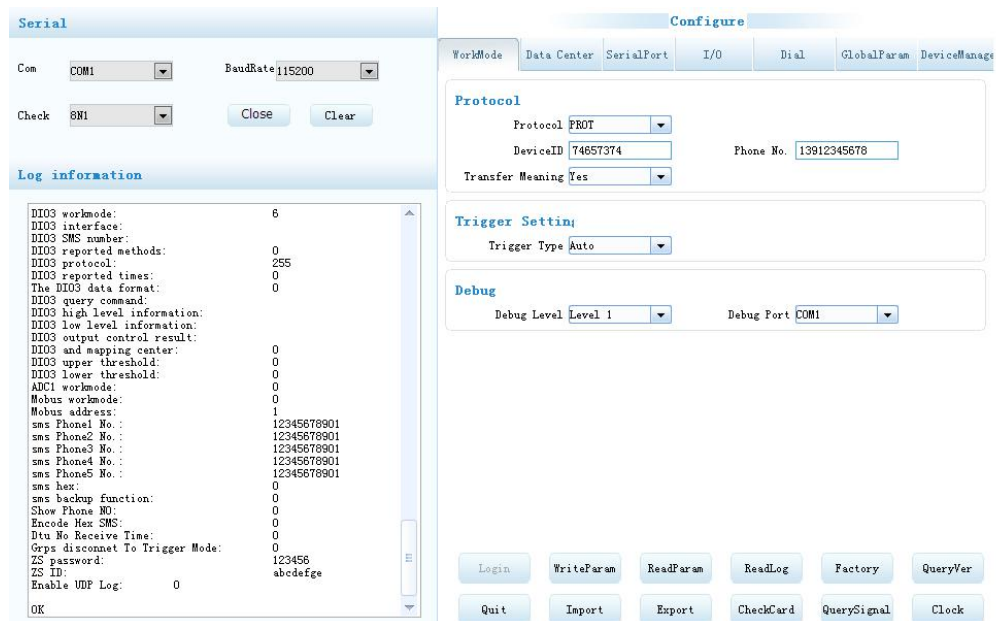

After Re-power IP MODEM, The configure tool will make it enter configure state. At the same time, the software will load current settings from IP MODEM and displays on the right configure columns. It's now ready to configure.

Note: To enter configure state for 4G device may need more time. It is about 40 seconds.

### 3.3.3 Work Mode

#### 3.3.3.1 App protocol

The IP Modem can be configured many communication protocols to adapt for different applications.

**Note : The tool will show the reference parameters according to the communication protocols setting.**

#### PROT

It uses TCP Protocol to send or receive data. In this mode, ID and phone number MUST be set.

<div style="border: 1px solid gray; padding: 10px;"> <p><b>App Protocol</b></p> <p>App Protocol <input type="text" value="PROT"/></p> <p>DeviceID <input type="text" value="74657374"/> Phone No. <input type="text" value="13912345678"/></p> <p>Transfer Meaning <input type="text" value="Yes"/></p> </div>	
DeviceID	ID number for the device. 8 characters
PhoneNo.	Phone number
Transfer Meaning	This item is only valid when the WorkMode is PROT. If this item is set to

	0, IP MODEM will transfer meaning to 0xfd and 0xfe. To know detail transfer meaning method, please refer “IP MODEM Transfer Meaning Explanation In the PROT work mode”. If this item is set to Yes, all the transmission is transparent.
--	--

**DCTCP**

This protocol is used in electric power field, with TCP protocol.

<p><b>App Protocol</b></p> <p>App Protocol <input type="text" value="DCTCP"/></p> <p>Phone No. <input type="text" value="13912345678"/></p>	
PhoneNo.	Phone number

**DCUDP**

This protocol is used in electric power field, with UDP protocol

<p><b>App Protocol</b></p> <p>App Protocol <input type="text" value="DCUDP"/></p> <p>Phone No. <input type="text" value="13912345678"/></p>	
PhoneNo.	Phone number

**TRNS**

The device work as MODEM for sending/receiving SMS, CSD and GPRS dialing.

<p><b>App Protocol</b></p> <p>App Protocol <input type="text" value="TRNS"/></p>	
--	--

**SMSCLI**

IP MODEM work as a SMS DTU. All data will send to binding phone number via SMS. The SMS from the binding phone number will send to Serial port.

<p><b>App Protocol</b></p> <p>App Protocol <input type="text" value="SMSCLI"/></p> <p>Phone No 1st Group <input type="text" value="12345678901"/></p> <p>Phone No 2nd Group <input type="text" value="12345678901"/></p> <p>Phone No 3rd Group <input type="text" value="12345678901"/></p> <p>Phone No 4th Group <input type="text" value="12345678901"/></p> <p>Show Phone Number <input type="text" value="Hide"/>      Hex To Text <input type="text" value="Disable"/></p>	
---	--



Pone No 1st Group	Bind phone number. Max phone number is 5 for one group
Pone No 2nd Group	
Pone No 3rd Group	
Pone No 4th Group	
Show Phone Number	If send phone number to serial port or not
Hex To Text	If convert HEX data to ASCII data or not

**SMSSER**

IP MODEM work as a SMS DTU. All the data paced with special format send to any phone number. he SMS from phone number will send to serial port.

	
Show Phone Number	If send phone number to serial port or not
Hex To Text	If convert HEX data to ASCII data or not

**Custom protocol : client mode**

It support TCP and UDP protocol with custom heart and login packet.

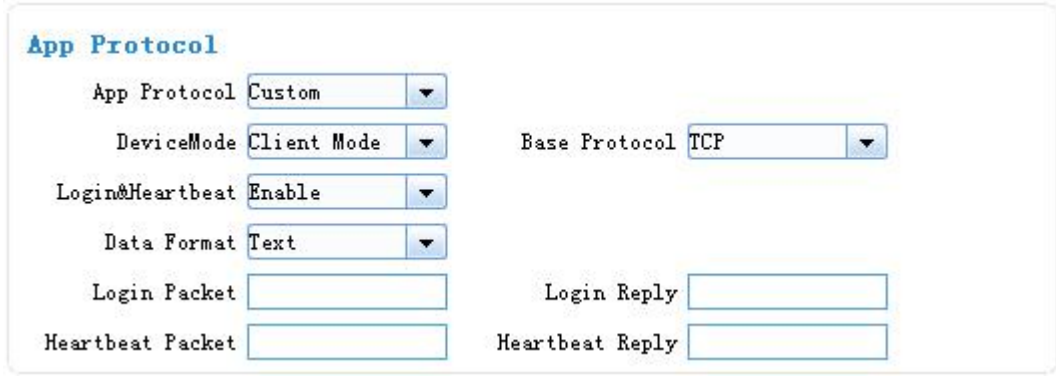
	
Base Protocol	TCP or UDP
DeviceMode	Client Mode: the IP Modem work as a client.
Login&Heartbeat	Enable: custom login and heart packet Disable: no login and heart packet. The flowing items can be ignored.
Data Format	Text: the flowing items are Text format Hex: the flowing items are Hex format
Login Packet	Login packet

Login Reply	Login packet respond
Heartbeat Packet	Heart packet
Heartbeat Reply	Heartbeat packet respond

**Custom protocol : Server mode**

It supports TCP and udp server.

**App Protocol**

App Protocol  ▼

DeviceMode  ▼      Base Protocol  ▼

Listen Port

Base Protocol	TCP or UDP
Listen Port	Listen port for service

**3.3.3.2 Trigger mode**

Normally, IP MODEM always keeps online and always be ready for data transmission. But in some circumstances, it's important to reduce wireless data flow. To realize this function, the software can makes IP MODEM into sleep state in idle time. When there is application data to transmit, IP MODEM can be triggered online ready for data transmission. There are total five methods to make IP MODEM online.

**AUTO**

IP MODEM always keeps online

**Trigger Setting**

Trigger Type  ▼

**SMSD**

send a special short message to make IP MODEM online.

Any phone number's SMS can wake up IP Modem, if the trigger number is empty. Otherwise only the trigger phone number's SMS can trigger the IP Modem.

**Trigger Setting**

Trigger Type  ▼

SMS Phone No.

SMS Password

SMS Phone No.	Trigger phone number. If it is empty, sms received from any phone no. can trigger the device
---------------	--

SMS Password	The content of SMS to trigger. If it is empty, any content of sms can trigger the device
--------------	--

**CTRL**

Make IP MODEM online through a phone call to IP MODEM.

Any phone number call can wake up IP Modem, if the trigger number is empty. Otherwise only the trigger phone number call can trigger the IP Modem.

**Note : if the trigger phone was set, the sim card in IP Modem Must have “caller ID display” function.**

	
CALL Phone No.	Trigger phone number

**DATA**

send special serial data to make IP MODEM online

	
Data Trigger On	If it was empty, any data form serial can trigger the IP Modem. The first frame data will be discarded because the IP modem was in deep sleep state.  If it is not empty, only the data matching to the “online data” can trigger the IP Modem.
Data Trigger Off	If it was empty, the IP Modem kept online.  If it is not empty, only the data matching to the “offline data” can made the IP Modem offline.
Trigger Port	Set the trigger data source from PORT1 or PORT2
Data Format	Format of the trigger data: Text or HEX

**I/O : Sleep and Wake up**

Made the IP Modem sleep or wake up via I/O level. If the I/O was in high level or suspend, the IP Modem was sleep. Otherwise, It would trigger the IP Modem wake up.

<div style="border: 1px solid #ccc; padding: 5px;"> <p><b>Trigger Setting</b></p> <p>Trigger Type <input type="text" value="I/O"/></p> <p>I/O type <input type="text" value="Sleep/Wakeup"/></p> <p>I/O Port <input type="text" value="I/O1"/></p> </div>	
Sleep/Wakeup	Made the IP Modem sleep or wake up depended on the I/O state
I/O	Set I/O port to trigger the IP Modem to sleep or wake up

**I/O : online or offline**

Made the IP Modem online or offline via I/O level. If the I/O was in high level or suspend, the IP Modem was offline. Otherwise, It would trigger the IP Modem online.

<div style="border: 1px solid #ccc; padding: 5px;"> <p><b>Trigger Setting</b></p> <p>Trigger Type <input type="text" value="I/O"/></p> <p>I/O type <input type="text" value="Online/Offline"/></p> <p>I/O1 Control <input type="text" value="ALL"/>      I/O2 Control <input type="text" value="ALL"/></p> <p>I/O3 Control <input type="text" value="ALL"/></p> </div>	
I/O type	Once it select “Online/Offline”, the bind IO state indication as follow, 1) high level made corresponding center online. 2) low level make corresponding center offline.
I/O1Control	ALL: all center online/offline NONE: do noting Center 1: center 1 online/offline Center 2:center 2 online/offline Center 3:center 2 online/offline Center 4: center 4 online/offline Center 5: center 5 online/offline
I/O2Control	the same as above
I/O3Control	the same as above

**MIXD**

the combination of SMSD, CTRL, DATA. IP MODEM will be online when meet one of these three trigger methods.

Trigger Setting	
Trigger Type	MIXD
CALL Phone No.	
SMS Phone No.	
Data Trigger On	don
Data Trigger off	doff
Trigger Port	COM1
Data Format	Text
I/O1 Control	ALL
I/O2 Control	ALL
I/O3 Control	ALL
SMS Password	

CALL Phone No.	Any phone number call can wake up IP Modem, if the trigger number is empty. Otherwise only the trigger phone number call can trigger the IP Modem.
SMS Phone No.	Any phone number's SMS can wake up IP Modem, if the trigger number is empty. Otherwise only the trigger phone number's SMS can trigger the IP Modem.
Data Trigger On	Online data
Data Trigger Off	Offline data
Trigger Port	Set the trigger data source from PORT1 or PORT2
Data Format	Format of the trigger data: Text or HEX

### 3.3.3.3 Debug Level

Debug information is used to debug software when there is software problem.

Debug	
Debug Level	Level 1
Debug Port	COM1

Debug Level	Close: no debug information output Level 1: simple prompt information output Level 2: detail debug information output
Debug Port	Port 1: debug info send to port 1 Port 2: debug info send to port 2 485: debug info send to RS485

### 3.3.4 Data Service Center Settings

Settings on this page are the parameters related to Data Service Center (DSC).

### 3.3.4.1 Data Service Center

IP MODEM support two Data Service Center methods to transmit data.

**Main and Backup:** IP MODEM always tries to connect with the Main DSC. If fails to connect with Main DSC, it will connect with Backup DSC at once

**Note:** If no Backup DSC exists, please configure the Backup DSC same as Main DSC.

**Multi Data Service Center:** IP MODEM can connect with at most five DSC at the same time. All the multi DSC can receive the same application data .

**Data Service Center Settings**

Data Center Number

Main Center  Port

Backup Center  Port

<div style="border: 1px solid #ccc; padding: 5px;"> <p><b>Main Backup Param</b></p> <p>Reconnect Int. (s) <input type="text" value="3"/></p> <p>Connect Retry Times <input type="text" value="5"/></p> <p>Back To Main Server <input type="text" value="No"/></p> </div>	
Reconnect Int.(s)	reconnect time interval in second
Connect Retry Times	reconnect times
Back To Main Server	<p>This item is only valid when you set “Data Center Number” as 1. In this mode, IP MODEM will switch to backup center when main center have problems. If this item is set to 1 , IP MODEM will check whether the main center work fine timely. When it detects the main server work fine, it will return back to the main server at once.</p>

If the Data Center Number is 0,there is no DSC working.

If the Data Center Number is 1, IP MODEM work in Main and Backup DSC method.

When “Data Center Number” is greater than 1, IP MODEM works in Multi Data Service Center method. The back center is invalid. The IP Modem will connect to mulit Data Center and transmit data.

**Data Service Center Settings**

Data Center Number

Main Center	<input type="text" value="120.42.46.98"/>	Port	<input type="text" value="19000"/>
2nd Center	<input type="text" value="120.42.46.98"/>	Port	<input type="text" value="19001"/>
3rd Center	<input type="text" value="120.42.46.98"/>	Port	<input type="text" value="19002"/>
4th Center	<input type="text" value="120.42.46.98"/>	Port	<input type="text" value="19003"/>
5th Center	<input type="text" value="120.42.46.98"/>	Port	<input type="text" value="19004"/>

### 3.3.4.2 Multi-Center Connection Check

This item is valid only when the “Data Center Number” is greater than 1. When one of the configured data center lost connection, IP MODEM will try to reconnect after the configured reconnect interval

**Multi-Center Connection Param**

Reconnect Int. (s)

Connect Retry Times

Data Send Type

Reconnect Int.(s)	reconnect time interval in second
Connect Retry Times	reconnect times
Data Send Type	ALL: Send data to all center Poll: send data to the centers order by order. Once data send success, it will stop to send to next other centers.

### 3.3.5 Serial port

IP MODEM support three individual serial ports, Port1, Port2 and RS485. All the three ports can enter configuration state. The default parameters of the port with baudrate 115200, data property 8N1

The data from the three port can bind to Data center.

<p><b>COM1</b></p> <p>BaudRate 115200 ▼</p> <p>Check 8N1 ▼</p> <p>Map Center ALL ▼</p>
<p><b>COM2</b></p> <p>BaudRate 115200 ▼</p> <p>Check 8N1 ▼</p> <p>Map Center ALL ▼</p>
<p><b>RS485</b></p> <p>BaudRate 9600 ▼</p> <p>Check 8N1 ▼</p> <p>Map Center ALL ▼</p>

COM1	<p>baud: the baud rate of the PORT</p> <p>110 --- 110 bps</p> <p>300 --- 300 bps</p> <p>600 --- 600 bps</p> <p>1200 --- 1200 bps</p> <p>2400 --- 2400 bps</p> <p>4800 --- 4800 bps</p> <p>9600 --- 9600 bps</p> <p>14400 --- 14400 bps</p> <p>19200 --- 19200 bps</p> <p>38400 --- 38400 bps</p> <p>56000 --- 56000 bps</p> <p>57600 --- 57600 bps</p> <p>115200 --- 115200 bps</p> <p>Property: Databit, Parity, Stopbit</p> <p>8N1 --- 8 Databit, No parity, 1 Stopbit</p> <p>8E1 --- 8 Databit, Even parity, 1 Stopbit</p> <p>8O1 --- 8 Databit, Odd parity, 1 Stopbit</p> <p>Bind: Center1: the data from the port send to center 1</p> <p>Center2: the data from the port send to center 3</p> <p>Center3: the data from the port send to center 3</p>
------	---



	Center4: the data from the port send to center 4 Center5: the data from the port send to center 5 ALL: the data from the port send to all centers Close: send to none
COM2	The same as above
RS485	The same as above

### 3.3.6 Dial

#### 3.3.6.1 PPP Dial

**PPP Dial**

DialNo

APN

UserName

Password

PPP Auth

QueryNetMode

DialNo	Network	Dial number
	GPRS/WCDMA/LTE	*99***1#、*99#、*98*1#
	CDMA/EVDO	#777
APN	Network	APN
	GPRS/WCDMA/LTE	cmnet、uninet
	CDMA/EVDO	empty
Username/password	Network	User name/password
	GPRS/WCDMA/LTE	empty
	CDMA/EVDO	card/card
PPP Auth	AUTO,PAP and CHAP	
QueryNetMode	Search the network mode for the 4G network	

### 3.3.6.2 PPP Redial

<div style="border: 1px solid #ccc; padding: 10px;"> <p><b>PPP Re-dial</b></p> <p>Re-dial Interval (s) <input type="text" value="30"/></p> <p>Dial Retry Times <input type="text" value="2"/></p> </div>	
Re-dial Interval(s)	The interval between ppp dial in second
Dial Retry Times	max times of ppp dial failure

### 3.3.6.3 DNS Parameters

When the DSC Internet access uses domain name, It's necessary to set DNS server resolving the DSC domain name. When the Data Center Number is 1, Main and Backup Center DNS Server is used to resolve the Main center and Backup center correspondingly.

<div style="border: 1px solid #ccc; padding: 10px;"> <p><b>DNS Setting</b></p> <p>Main DNS <input type="text" value="8.8.8.8"/></p> <p>Backup DNS <input type="text" value="8.8.8.8"/></p> </div>	
Main DNS	The DNS server IP address(must be IP address)
Backup DNS	The DNS server IP address(must be IP address)

### 3.3.7 Global Parameters

#### 3.3.7.1 PPP Link Check

PPP Link Check adopt LCP echo method to check the link status. Once the check failure's times meet the max times. The IP Modem will re-dial.

<div style="border: 1px solid #ccc; padding: 10px;"> <p><b>PPP Link Check</b></p> <p>Lcp Echo <input type="text" value="Enable"/></p> <p>Echo Interval (s) <input type="text" value="60"/>      Echo Times <input type="text" value="5"/></p> </div>	
Lcp Echo	Enable or Disable
Echo Interval(s)	The interval should not be too small. 60 is recommended. (in second)
Echo Times	>= 3 times

#### 3.3.7.2 ICMP Link Check

ICMP link check send to server a icmp packet and wait reply to check the link status. If the reply is lost, it means that the link may be broken.

<p><b>ICMP Check</b></p> <p>ICMP Check <input type="text" value="Enable"/></p> <p>Dest Address <input type="text"/> Check Interval (s) <input type="text" value="60"/></p> <p>Check Times <input type="text" value="5"/></p>	
ICMP Check	Enable or Disable
Dest Address	The destination address of ICMP packet to send
Check Interval(s)	The interval should not be too small. 60 is recommended(in second)
Check Times	>= 3 times

### 3.3.7.3 Other Parameters

<p><b>Others</b></p> <p>SMS Center <input type="text"/> Heartbeat Int. (s) <input type="text" value="60"/></p>	
SMS Center	Your local SMS center number. It should set according to the local operation.
Heartbeat Int.(s)	Time interval sent heartbeat packet. (in second)

### 3.3.7.4 Data Frame Parameters

<p><b>Data Frame Setting</b></p> <p>Bytes Interval (MS) <input type="text" value="20"/> MTU <input type="text" value="1450"/></p>	
Bytes Interval(MS)	The time interval used to determine whether the serial data frame transmission has completed, IP MODEM will send the serial data to the center when two bytes transmit time interval larger than this item value.(in milliseconds)
MTU	TCP Max packet length

## 3.3.8 Device Manage

### 3.3.8.1 Device Manage Center Parameters

The IP Modem send device status information to the Device Manage Center. The information include network signal, network status, traffic flow and so on.

The Device Manage Center also query and configure the device parameters.

Device Manage Setting	
Device Manage	Enable
Connection Type	Separated
Dev ID For Manage	
Service Address	120.42.46.98
Protocol	TCP
Port	44002

Device Manage	Enable or Disable
Connection Type	separate: data service and manage service are separated from each other by transmitting data in two connection. combine: data service and manage service transmit in one connection together.
Dev ID For Manage	Device ID for manage center. 8 character
Protocol	TCP or UDP
Service Address	manage center server address
Port	manage center server port

### 3.3.8.2 Manage by SMS

Configure the IP Modem by SMS

SMS Manage	
SMS Configure	Enable
Configure Password	123456
Manage Phone No	
Exception Report	Enable

SMS Configure	Enable or Disable
Configure Password	The password for SMS Configure
Manage Phone No.	If it is empty, any number can configure the IP Modem Parameters. Otherwise, only the "Administrator Number" can configure the IP Modem Parameters.
Exception Report	Enable, exception information report by SMS Disable, do nothing when exceptions meet

### 3.3.9 Miscellaneous

<div style="display: flex; justify-content: space-around; text-align: center;"> <div style="border: 1px solid #ccc; border-radius: 10px; padding: 5px 15px; background-color: #e0f0ff;">Login</div> <div style="border: 1px solid #ccc; border-radius: 10px; padding: 5px 15px; background-color: #e0f0ff;">WriteParam</div> <div style="border: 1px solid #ccc; border-radius: 10px; padding: 5px 15px; background-color: #e0f0ff;">ReadParam</div> <div style="border: 1px solid #ccc; border-radius: 10px; padding: 5px 15px; background-color: #e0f0ff;">ReadLog</div> <div style="border: 1px solid #ccc; border-radius: 10px; padding: 5px 15px; background-color: #e0f0ff;">Factory</div> <div style="border: 1px solid #ccc; border-radius: 10px; padding: 5px 15px; background-color: #e0f0ff;">QueryVer</div> </div> <div style="display: flex; justify-content: space-around; text-align: center; margin-top: 10px;"> <div style="border: 1px solid #ccc; border-radius: 10px; padding: 5px 15px; background-color: #e0f0ff;">Quit</div> <div style="border: 1px solid #ccc; border-radius: 10px; padding: 5px 15px; background-color: #e0f0ff;">Import</div> <div style="border: 1px solid #ccc; border-radius: 10px; padding: 5px 15px; background-color: #e0f0ff;">Export</div> <div style="border: 1px solid #ccc; border-radius: 10px; padding: 5px 15px; background-color: #e0f0ff;">CheckCard</div> <div style="border: 1px solid #ccc; border-radius: 10px; padding: 5px 15px; background-color: #e0f0ff;">QuerySignal</div> <div style="border: 1px solid #ccc; border-radius: 10px; padding: 5px 15px; background-color: #e0f0ff;">Clock</div> </div>	
Login	Enter configuration state while IP Modem normal work.
WriteParam	Send parameters to IP Modem
ReadParam	Read All parameters of IP Modem
ReadLog	Read log information of IP Modem
Factory	Factory the IP Modem's parameters
QueryVer	Query the version of IP Modem
Quit	Quit configuration state
Import	Import parameters from file to IP Modem
Export	Export parameters from IP Modem to file
CheckCard	Check SIM card
QuerySignal	Query the CSQ of IP Modem
Clock	Set the system time for IP Modem

## Appendix

The following steps describe how to make IP MODEM enter configure state with the Windows XP Hyper Terminal.

1. Press “Start”→”Programs”→”Accessories”→”Communications”→”Hyper Terminal”



2. Input connection name, choose “OK”
3. Choose the correct COM port which connect to IP MODEM, choose “OK”



4. Configure the serial port parameters as following, choose “OK”

Bits per second: 115200

Data bits: 8

Parity: None  
Stop bits: 1  
Flow control: None

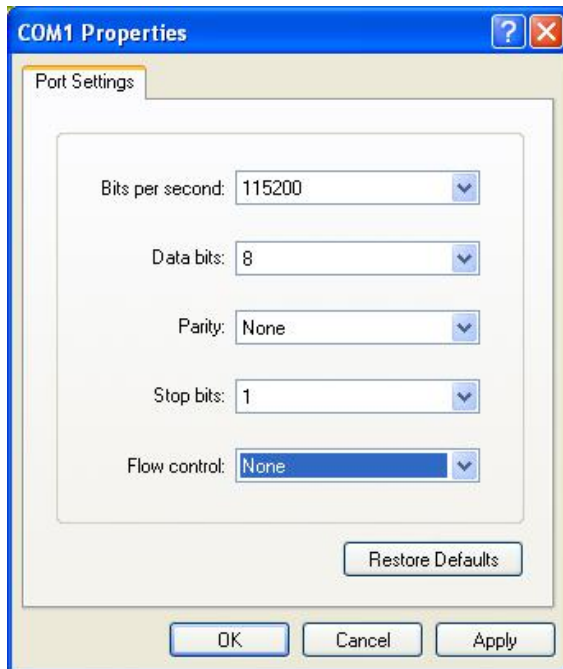

5. Complete Hyper Terminal operation, It runs as following

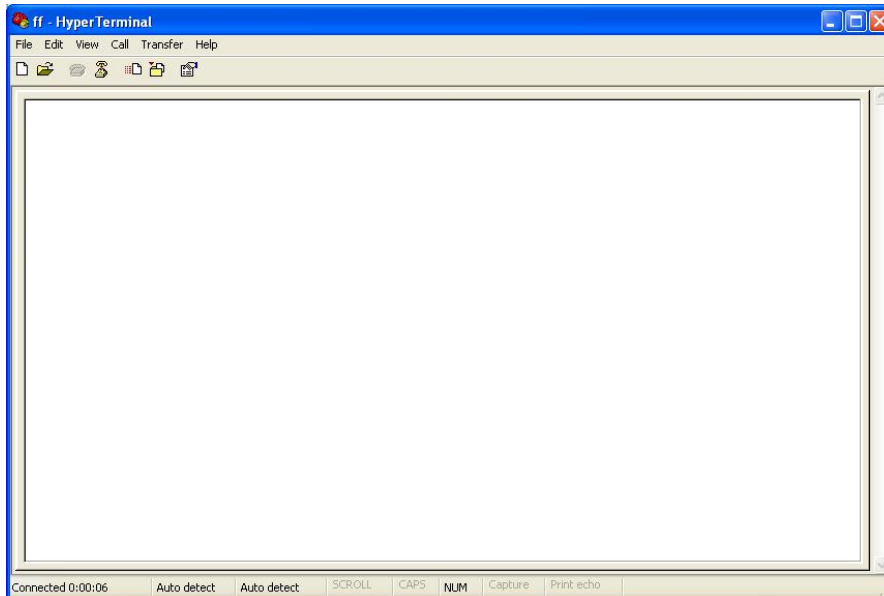

6. Re-power IP MODEM, put mouse focus on the Hyper Terminal and press “s” key continuously until IP MODEM enter configure state as following

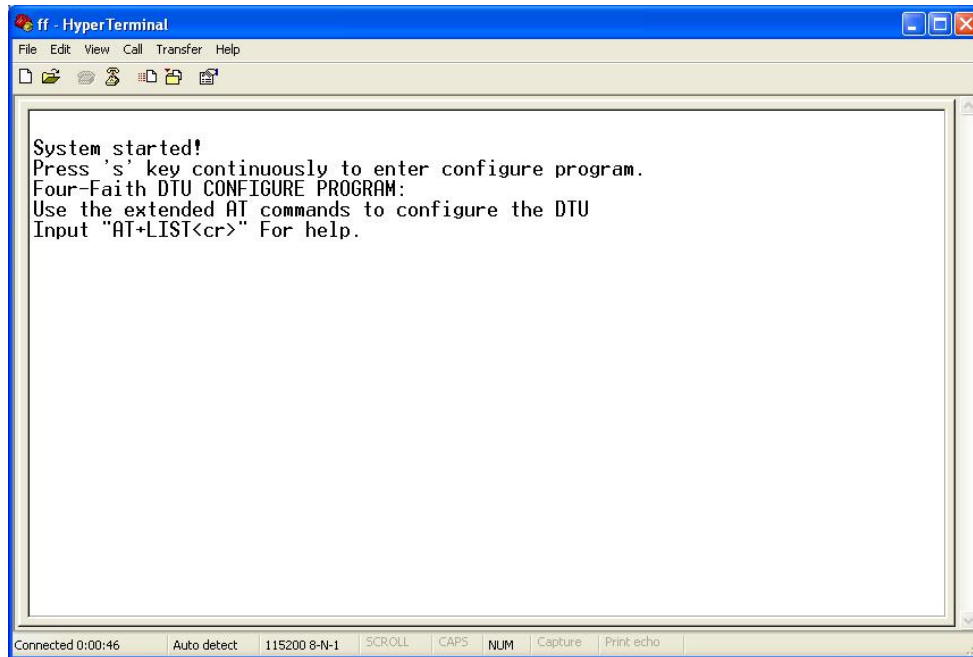

7. IP MODEM has entered configure state, you can configure the parameters through AT command.